

U-WAVE

NEW SYSTEM IMPROVES WORKABILITY BY ELIMINATING LONG
AND CUMBERSOME CABLES WHEN COMMUNICATING DATA TO A PC

SMALL TOOL INSTRUMENTS
AND DATA MANAGEMENT



Measurement Data Wireless Communication System U-WAVE

The U-WAVE system enables easy wireless data communication from a measuring tool to a PC using the Digimatic protocol. Measurement workability is improved by eliminating the long and cumbersome data cables usually required and the user-friendly interface allows data to be loaded into any software product that accepts keyboard input, such as Excel* or Notepad.

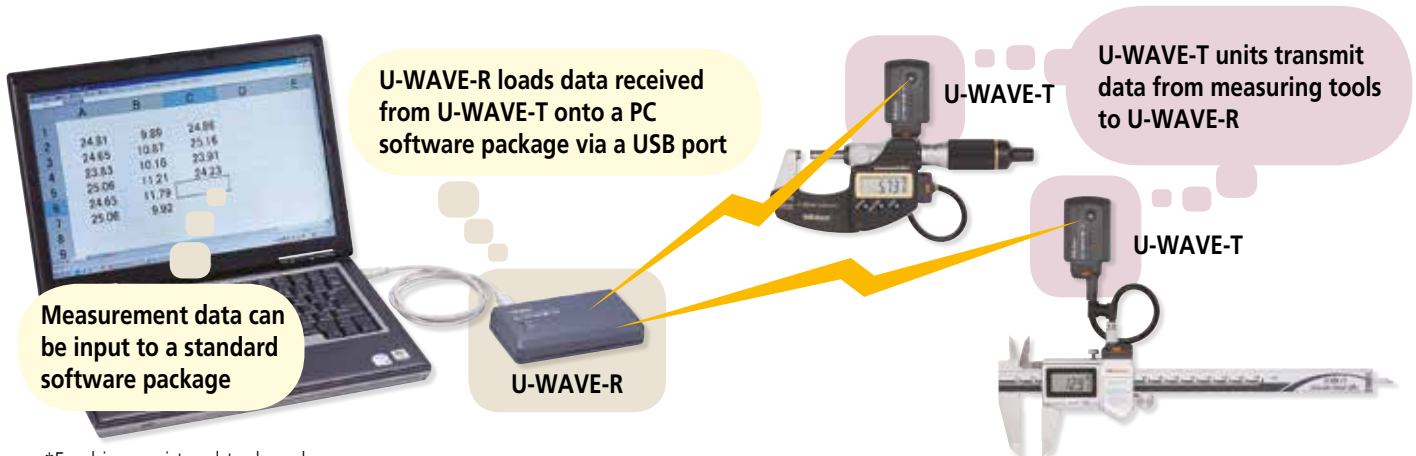

*Excel is a registered trademark of Microsoft Corporation.

Note: According to the radio regulations the use of this product is permitted in the specified countries and regions. (details on page 6). This product must not be used in other countries or areas.

Easy loading in Excel format

The **U-WAVEPAK**, **U-WAVE-R** standard package features a keyboard interface function. This allows measurement data to be easily loaded to a PC in Excel, Notepad or other format that accepts numeric value input via a keyboard.

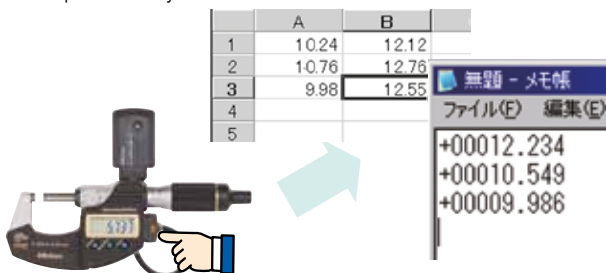

In addition, a virtual COM driver allows measurement data to be input to a program that supports **RS-232C** serial communication. However, note that the communication speed (baud rate) is fixed to 57,600 bps.

Approximately 400,000 data transmissions

One commercially available CR2032 lithium battery can be used for about 400,000 data transmissions. Assuming that the device is used twenty days a month, sending data 2,000 times a day, one battery would last for about ten months.

Dustproof and water resistant IP67 model

IP67-type **U-WAVE-T** (No.02AZD730D) has an **IP67**-level dust/water-proof function. This model can be used in combination with, for example, a coolant-proof caliper, micrometer or indicator.



IP67

Reception is reported by LEDs (and a beep sound). Patent pending (Japan)

The **U-WAVE-T** main unit has two LEDs and a buzzer* that can be used to check if sent data was successfully received.

*Beep indication is supported by the buzzer type **No.02AZD880D** only.



U-WAVE

Up to 100 measuring tools can be connected to one U-WAVE-R unit

Up to 100 **U-WAVE-T** units can be registered with one **U-WAVE-R** unit, and up to 16 **U-WAVE-R** units can be connected via a commercially available USB hub.

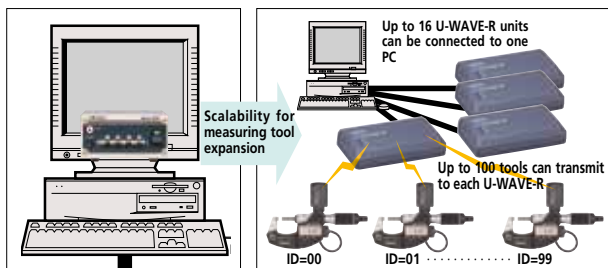

MUX-10F (up to 4 wired channels) **U-WAVE** (up to 100 wireless channels)

Cordless operation improves workability in measurement data recording

Measurement on surface plate

With a cordless device, the surface plate and PC desk no longer need to be adjacent, enabling freer layout in the inspection room.

Measurement of large workpieces

With **U-WAVE** operators can perform measurement freely walking around the workpiece. There are no cable constraints.

Measurement using long measuring tools

Long measuring tools are hard to handle, but **U-WAVE** eliminates cable constraints and improves workability.

Data communication range up to 20 m possible

The maximum reliable communication range is approximately 20 m*. Even when multiple **U-WAVE-R** units are used within the range of 20 m, interference does not occur since an ID (00 to 99) is assigned to each unit. Radio interference between **U-WAVE-R** units can also be avoided by setting different frequencies (selected from 15 bands).

*The range achievable depends on the local radio transmission characteristics.

Substantial cost reduction compared with conventional Mu-WAVE models

With a variety of function improvements, this product is now available at a lower price due to substantial cost reductions.

Different frequencies ensure no radio interference

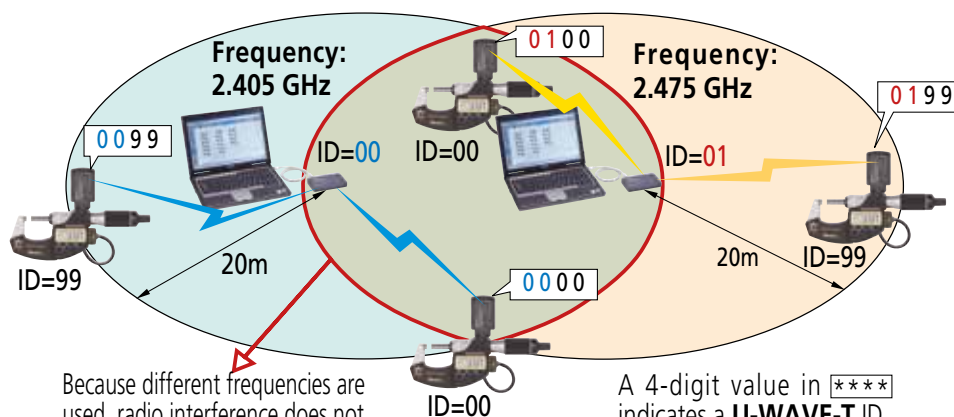

Because different frequencies are used, radio interference does not occur even when multiple devices are used in the same communication range.

A 4-digit value in indicates a **U-WAVE-T** ID.

Just pressing a switch loads measured data onto a PC through wireless communication.

Purchase the following four products (1 to 4) to enable data loading onto your PC.

3 U-WAVE-T/tool connection

A short cable is used to connect a measuring tool to its **U-WAVE-T** unit. Select the appropriate cable from **A** to **G** below (7 types) to suit the measuring tool. Detailed information on cable suitability is given on page 10.

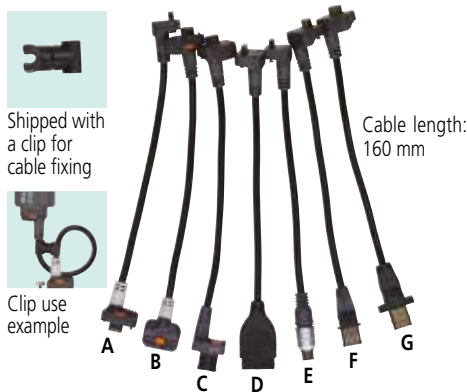

Type	Order No.
A Water-proof model with output button	02AZD790A
B Water-proof model with output button	02AZD790B
C With data-out button type	02AZD790C
D 10-pin plain type	02AZD790D
E 6-pin round	02AZD790E
F Plain type straight	02AZD790F
G Plain type straight water-proof model	02AZD790G

2 U-WAVE-T · Registered design (Japan)

U-WAVE-T sends measurement data to **U-WAVE-R**. Select IP67 or buzzer model, according to your application.



The buzzer model has a hole so that you can hear the sound.

Major specifications of U-WAVE-T

Model	U-WAVE-T (IP67 model)	U-WAVE-T (buzzer model)
Order No.	02AZD730*	02AZD880*
Protection Rating	IP67	-
Data reception indication	LEDs	Buzzer and LEDs
Power supply	Lithium battery CR2032×1	
Battery life	Approx. 400,000 transmissions	
External dimensions	44 x 29.6 x 18.5 mm	
Mass	23 g	

*Detailed information on order No. and conformity standards of wireless communication specification is given on page 6.



Standard accessory: driver

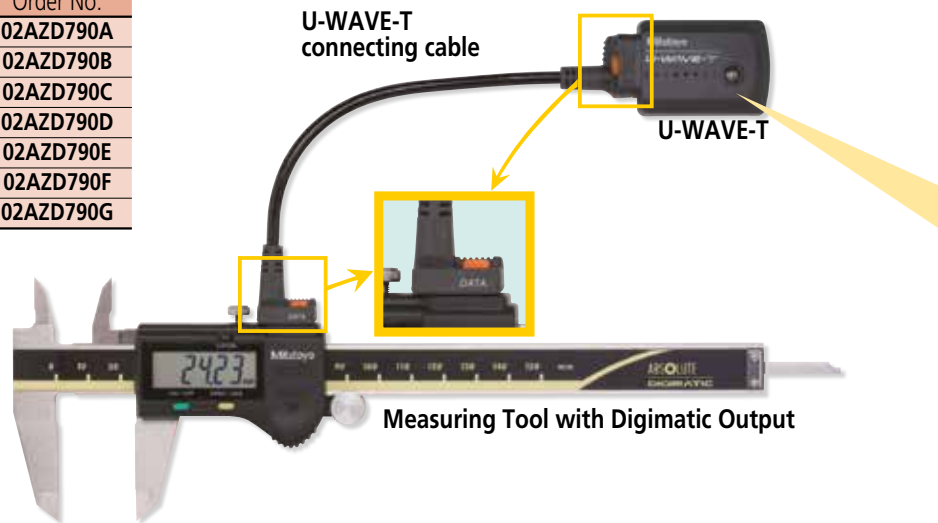

4 Mitutoyo Measuring Tool with Digimatic Output

This product can be connected to a measuring tool that provides Digimatic data output. Digimatic output is Mitutoyo's proprietary output format. The Digimatic specifications remain unchanged since the first Digimatic measuring tool was released. Therefore any tool having a Digimatic port can be used, regardless of whether the instrument is new or old, although note that the connectors on some older instruments are not compatible with the connectors used on the above-listed cables. Check with the cable list on page 10.

Some Digimatic measuring tools pictured with suitable connecting cables. The product numbers for the cables are shown underneath the instrument descriptions.



Super Caliper CD67-S15PM
No.02AZD790A



QuantuMike MDE-25MJ
No.02AZD790B



ABS Digimatic Caliper CD-15CX
No.02AZD790C



Digimatic Indicator ID-H0530
No.02AZD790D

U-WAVE

U-WAVE

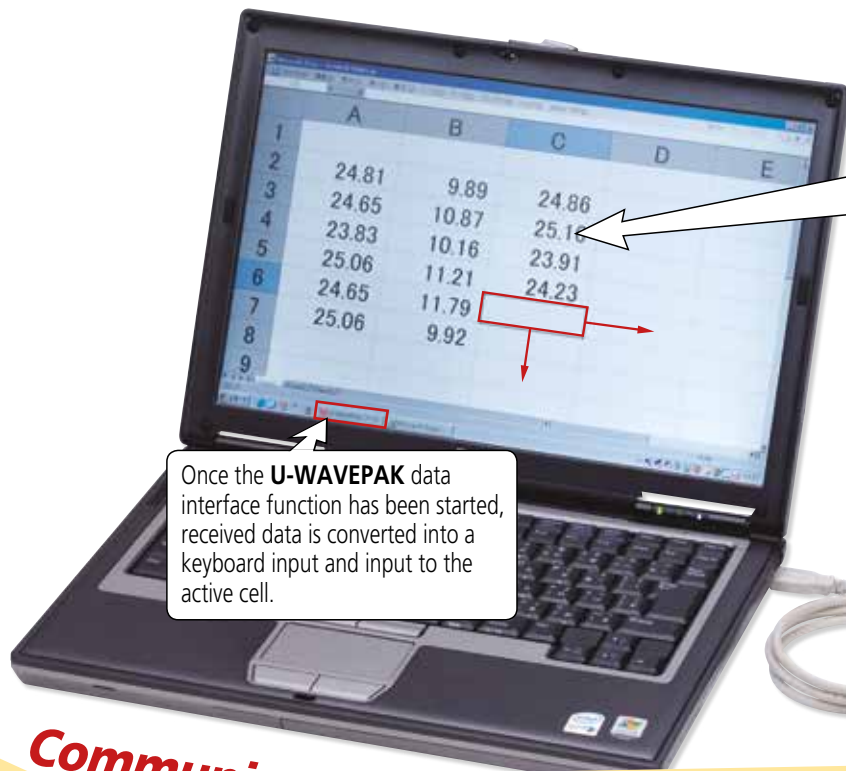

Once the **U-WAVEPAK** data interface function has been started, received data is converted into a keyboard input and input to the active cell.

When the data input button is pressed, the value displayed by the measuring tool is input to the active cell of Excel followed by "Enter" key input. The cursor movement direction after input (up, down, left or right) can be set in Excel.

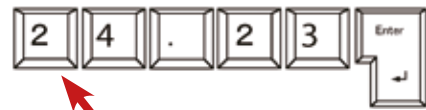

Standard **U-WAVEPAK** setup software



USB 2.0 cable (1 m)



U-WAVE-R main unit



Wall installation board

Communication distance of approximately 20 m (in a good transmission/reception location)

**Refer to page 6 for wireless communication specification*

1 U-WAVE-R · Registered design (Japan)

Major specifications of U-WAVE-R

Model Order No.	U-WAVE-R 02AZD810*
Power supply	USB bus power system
Number of U-WAVE-R units that can be connected to one PC	Up to 16
Number of U-WAVE-T units that can be connected	Up to 100
External dimensions	140 × 80 × 31.6 mm
Mass	130 g



Quick Micro MDQ-30M No.02AZD790E



Digimatic Height Gauge HD-30AX No.02AZD790F



ABS Digimatic Indicator ID-N112 No.02AZD790G



*Detailed information on order No. and conformity standards of wireless communication specification is given on page 6.

*Refer to page 6 for specification of **U-WAVEPAK** (setup software)

Specifications of wireless communication

Wireless standards	Conform to IEEE802.15.4	Wireless communication distance	Approx. 20 m (within visible range)
Wireless communication speed	250 kbps	Transmission output	1 mW (0 dBm) or less
Modulation method	DS-SS (direct sequence spread spectrum) Resistant to interfering signal or noise.		
Communication frequency	2.4 GHz band (ISM band: universal frequency)		
Used band	15 channels (2.405 to 2.475GHz at intervals of 5MHz) The noise search function can avoid interference with other communication devices.		

Note: This product is not compatible with the conventional Mu-WAVE, for which communication specifications are different.

Conformity standards	
·Japanese conformity standards	ARIB STD-T66
·European conformity standards	EN 50371:2002
	EN 300 440-1 V1.3.1
	EN 300 440-2 V1.1.2
	EN 301 489-01 V1.6.1
·U.S.A. conformity standards	47 CFR Part 15.247:(Subpart :C)
	47 CFR Part 15,(Subpart :B)
·Canada conformity standards	RSS-210 (Issue 7)
	RSS-Gen (Issue 2)
	ICES 003 (Issue 4)
·Mexican conformity standards	COFETEL DEL 13 DE MARZO DE 2006
·Brazilian conformity standards	Resolution 442 and Resolution 506

Note: According to the radio regulations the use of this product is permitted in the following countries or areas. This product must not be used in other countries or areas.

Order No.	Countries or areas
02AZD810D, 02AZD730D, 02AZD880D	Japan, Europe (a total of 32 countries including 27 EU members, 4 EFTA members and Turkey), U.S.A. and Canada Mexico (Available for only products labeled with a wireless accreditation label for Mexico)
02AZD810E, 02AZD730E, 02AZD880E	Brazil

1 U-WAVE-R

Receives data from U-WAVE-T and loads it onto a PC via a USB connection

Specifications of U-WAVEPAK (setup software)

Before using **U-WAVEPAK** for the first time after purchase, IDs, frequencies, and other settings must be made. The data interface function allows measurement data to be loaded into a PC in Excel, Notepad or other software file that accepts keyboard input.

Data can also be input to a program that supports **RS-232C** serial communication using the virtual COM driver.

1) Operating environment

Supported OS: Windows 2000 Professional (SP4 or higher)
Windows XP Home Edition (SP2 or higher)
Windows XP Professional (SP2 or higher)
Windows Vista
Windows 7

Other information: USB port needed

2) Initial setup procedure

- (1) Install the **U-WAVEPAK** (setup software).
- (2) Connect the **U-WAVE-R** main unit to the PC with a USB 2.0 cable.
- (3) Install the dedicated USB driver and virtual COM driver.
- (4) Set IDs and frequencies for **U-WAVE-R** and **U-WAVE-T** with **U-WAVEPAK**.
- (5) Press the DATA button of **U-WAVE-T** once to write settings into **U-WAVE-T**. Once this procedure has been performed when using **U-WAVE-T** for the first time, settings are then stored in the main unit memory.

Accessories (optional)

Foot switch type connecting cable

Connect one of the optional foot switch type connecting cables in place of the standard cable to use the foot switch. Select an appropriate cable that fits the measuring tool to be connected.

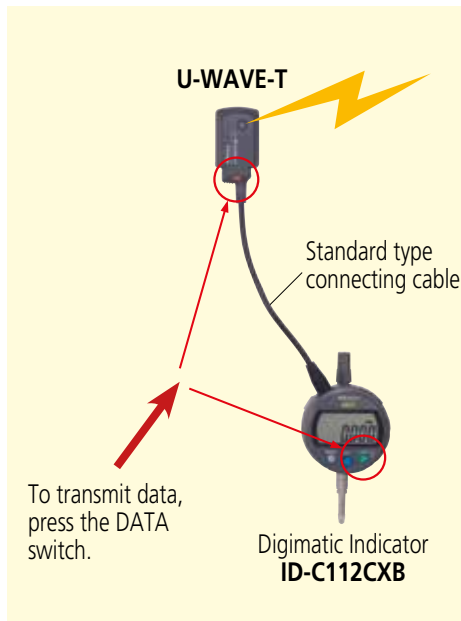

Or use the foot switch to send data

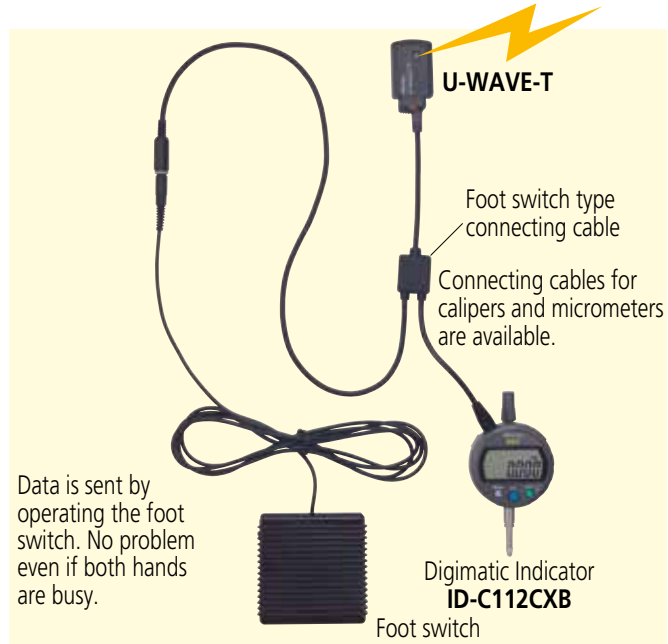

If the standard connecting cable is connected:
Data is sent by one press on the switch on the connecting cable connector (U-WAVE-T end).

If the foot switch is connected:
Data is sent by one press on the optional foot switch (No.937179T).

External view and dimensions example Order No.02AZE140F

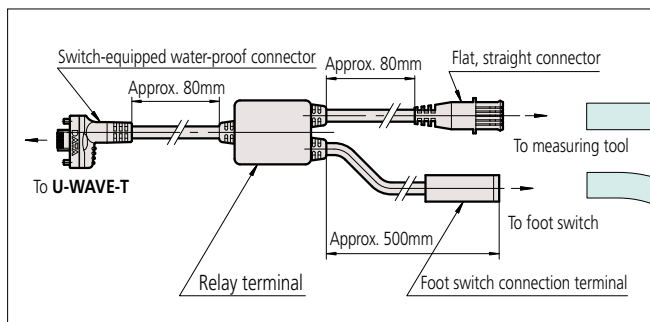

Select a connector type according to the measuring tool to be used.

Order numbers

Select a connecting cable from among the following 7 types (A to G) that fits the measuring tool. For detailed information, refer to the list of connecting cables on page 10.

Connector type	Order No.
A Water-proof with switch	02AZE140A
B Water-proof with switch	02AZE140B
C With switch	02AZE140C
D 10-pin plain	02AZE140D
E 6-pin round	02AZE140E
F Straight type	02AZE140F
G Water-proof straight type	02AZE140G

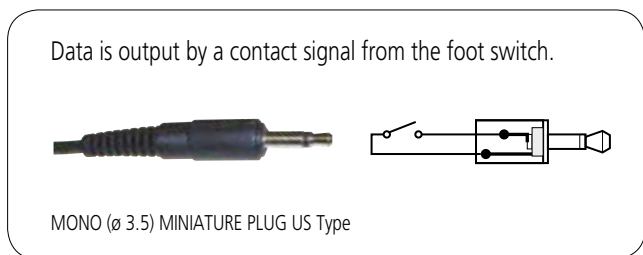

Foot switch (optional)

Order No.937179T

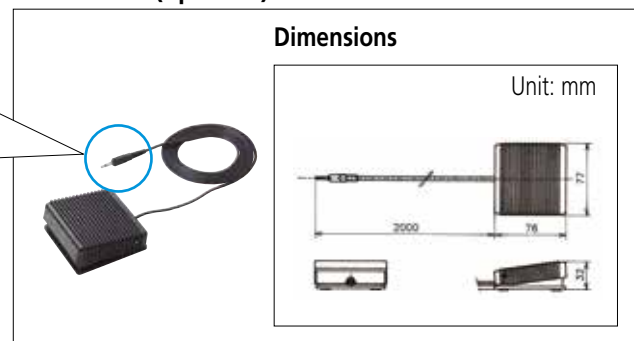

Accessories (optional)

U-WAVE-T Holder Kit

A plastic mounting plate is provided to enable the **U-WAVE-T** unit and measuring tool to be held together by means of adhesive-backed hook and eye fasteners. This method makes attaching/detaching the tool and **U-WAVE-T** unit quick and convenient. Batteries can be replaced without needing to detach the tool.



Dimensions

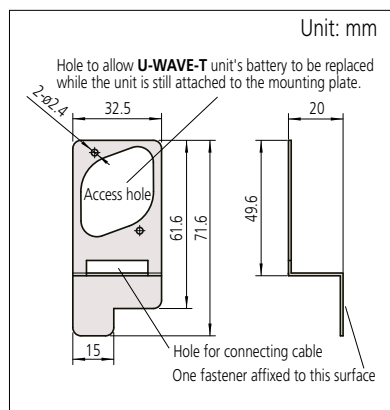

U-WAVE-T Instration Kit Part No.02AZE200

Accessories

- Detachable fasteners: 2 pieces (mirror-imaged)
- Mounting screws: 4 pieces (including 2 spares)

Mounting drawing

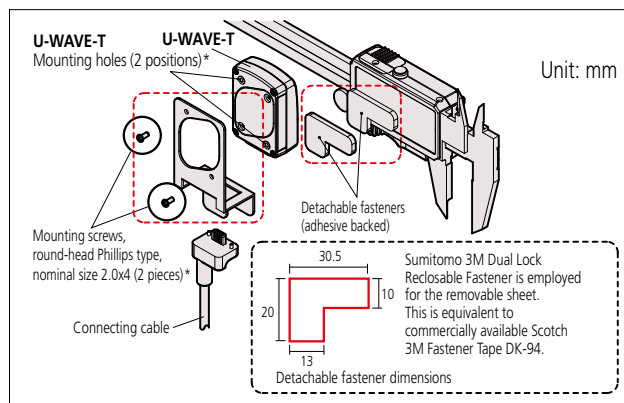

* To avoid damaging the threaded holes in the plastic body of the U-WAVE-T unit, the mounting screws should be tightened only just sufficiently to grip. Repeated removal of these screws should also be avoided for the same reason.

** In order to avoid loss of adhesion, do not allow oil or coolant to come into contact with the bonding surfaces of the detachable fasteners.

Major measuring tools intended to use the U-WAVE-T mounting plate

Series No.	Product name	
500	ABS Coolant Proof Caliper	CD-PMX/PM/GM
	Super Caliper	CD-SPM
	ABS Digimatic Caliper	CD-CX/C
293	Coolant Proof Micrometer	MDC-MJ/MJT/ MDE-MJ
	ABS Digimatic Indicator	ID-CXB/ID-SB

Other measuring tools than the above-mentioned can also be used if they have a flat area big enough to accept the detachable fastener (refer to the dimensions on the mounting drawing). However, note that the positional relationship of the connector and **U-WAVE-T** unit needs to be carefully considered when establishing the connecting cable run.

Typical fastener locations on measuring tools

Digimatic Indicator

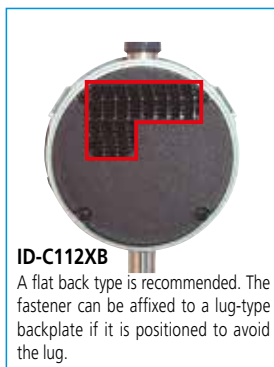

Digimatic Caliper

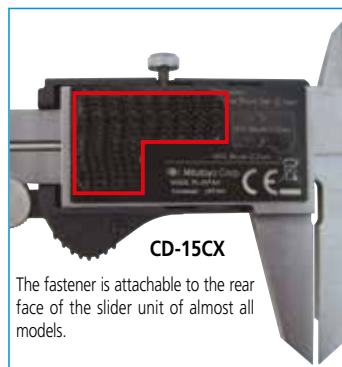

Digital Micrometer

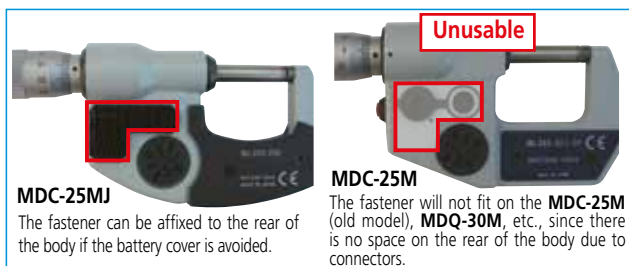

The mounting plate in use

SuperCaliper CD67-S15PM



QuantuMike MDE-25MJ



Digimatic Indicator ID-C112XB



Example/dimensions/precautions

Support of data request from a PC (Event Drive mode)

For detailed information, contact the nearest Mitutoyo Sales Department.

This Event Drive enables data request from the PC end. This system is effective if no operator is in attendance on a measuring tool or if the tool is installed at an inaccessible site. (Data acquisition from a measuring tool such as a Digimatic Indicator mounted on a machine or a jig.)

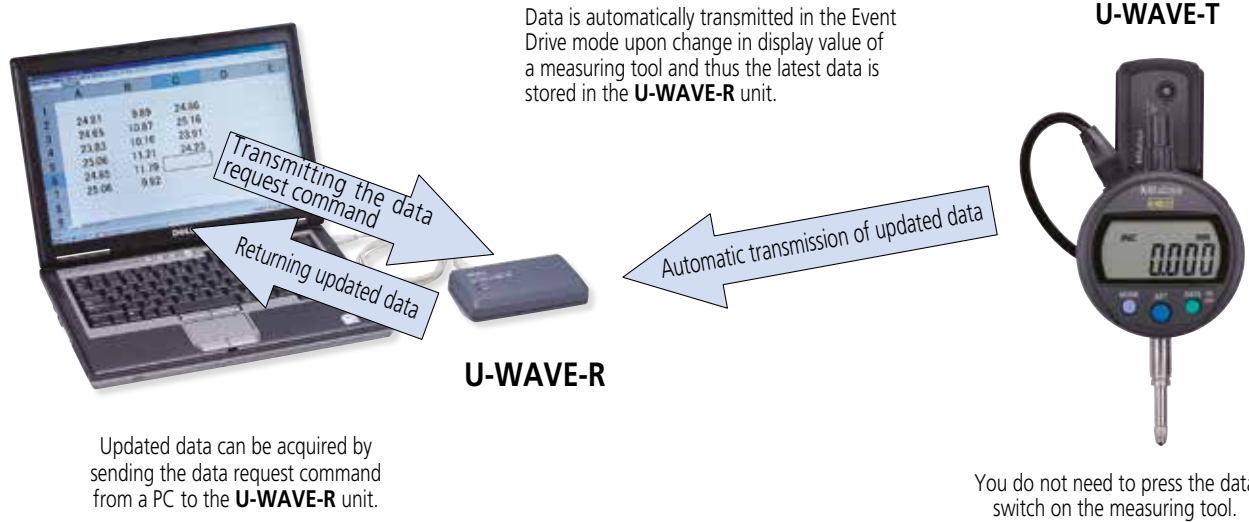

Create a program that supports the data request command as system software by the customer or use Mitutoyo MeasureReport V4.1.

Precautions

- 1 About battery life:
The battery lifespan in the Event Drive mode is shorter than that in the Normal mode (button-drive). Change to the Normal (button-drive) mode after every measurement to extend the battery life span.
- 2 If using multiple measuring tools:
If multiple **U-WAVE-T** units are connected to one **U-WAVE-R** unit in the Event Drive mode, a communication error could result due to conflict between the signals when data is transmitted simultaneously from the **U-WAVE-T** units since they use the same frequency. To avoid any transmission conflict, shift the timing of each measurement or provide enough **U-WAVE-R** units (a maximum of 16 units are connectable) for each measuring tool and set different frequencies (15 channels).

Physical features and dimensions

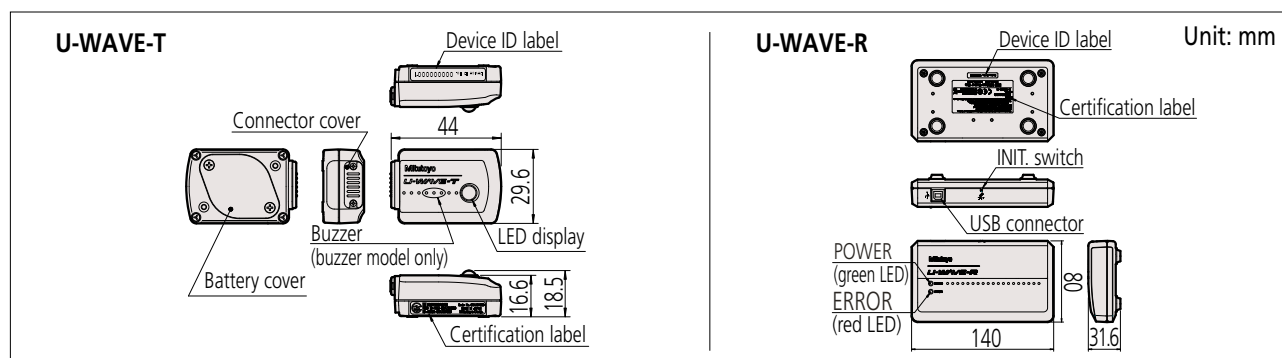

Precautions for use in radio communication environments

The **U-WAVE** communication distance is approximately 20 m line-of-sight. The system may not deliver its full performance in an environment detrimental to transmission. (Refer to Table 1.)

Safety precautions

Do not use the **U-WAVE-T** and **U-WAVE-R** units near a medical device due to risk of causing a malfunction due to electromagnetic interference. (Refer to Table 2.)

Radio law requirements

These **U-WAVE** units have obtained accreditation as 2.4GHz-band advanced small-power data communication systems in compliance with the radio communication laws in the specified countries and regions. (Details on page 6)

These laws prohibit the disassembly or modification of these units or their use without the accreditation label affixed to the body.

Table 1 Features that could impair data communication between U-WAVE units

Feature	Effect
Concrete wall	Disables data communication if any unit is completely enclosed by a concrete wall.
Metallic partition or similar structure	May reduce communication speed or block data transmission.
Communication devices for wireless LAN, ZigBee, Bluetooth, etc., or a microwave oven	May reduce communication speed or block data transmission. A remedy is to separate the communication channel (band ID) and installation site of each device as far as possible from the U-WAVE-R unit.
Machine tools, etc.	May reduce communication speed or block data transmission at worksites where machine tools such as electrical discharge machines, carrier cranes, arc welders, etc., are operating.

Table 2 Equipment that could be affected by U-WAVE units

Device	Effect
Medical equipment	Using U-WAVE units near a medical device such as a laser surgical knife or electronic scale may cause that device to malfunction.

Connecting cables

Two types of connecting cable

A much-needed foot switch type connecting cable (lower drawing at right) has been provided in addition to the conventional type (upper drawing at right) of connecting cable between the **U-WAVE-T** unit and a measuring tool. Identify the connector type compatible with your measuring tool in the following table listing 7 types (**A** to **G**), and select either the standard type or foot switch type cable according to the purpose. The table also lists wired-type connecting cables with the same connector as those 7 types on each measuring tool. Specify those cables as required.

Foot switch (optional)
Order No. **937179T**

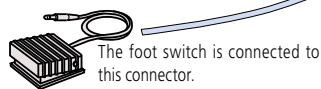

Measuring tool end U-WAVE-T unit end

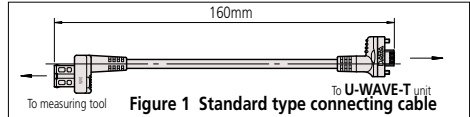

Figure 1 Standard type connecting cable

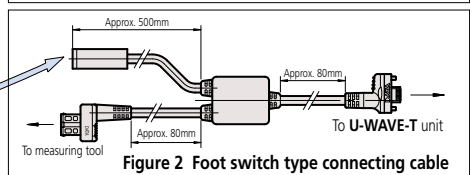
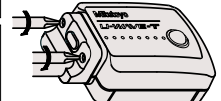

Figure 2 Foot switch type connecting cable



Fasten the connector to **U-WAVE-T** with two screws.

Cable type		A Water-proof with switch	B Water-proof with switch	C With switch	D 10-pin plain	E 6-pin round	F straight type	G Water-proof straight type
Standard type	Order No.	02AZD790A	02AZD790B	02AZD790C	02AZD790D	02AZD790E	02AZD790F	02AZD790G
Foot switch type	Order No.	02AZE140A	02AZE140B	02AZE140C	02AZE140D	02AZE140E	02AZE140F	02AZE140G
Plug that connects to the measuring instrument		Light gray	Light gray					
Socket type on the measuring instrument								
Major compatible measuring instruments		[Digimatic Caliper /Super Caliper] -500 series CD67-S_PM CD-PMX/PM/GM -550/551 series CDC-P_PMX CDN-P_PMX [Digimatic Carbon Fiber Caliper] -552 series CFC-G/GL/GC/GU [Digimatic Depth Gage] -571 series VDS-PMX [Digimatic Scale Unit] -572 series SD-G [Digimatic Exclusive Caliper] -573 series NTD-PMX/PM	[Digimatic Micrometer, QuantuMike] -293series MDC-MJ/MJB/MJT MDE-MJ [Tubular Inside Micrometer] -337 series IMZ-MJ -339 series IMJ-MJ [Digimatic Micrometer Head] -350 series MHN-MB/MJB/MJNB [Digimatic Exclusive Micrometer] (Models with suffix MJ/MJB/M/MB/PM/PMB) [Digimatic Holtest] -468 series HTD-R	[Digimatic Micrometer Head] -164 series MHD-MB [Digimatic Caliper] -500 series CD-CX/C/S_C -550/551 series CDC-C/CX, CDN-C/CX [Digimatic Depth Gage] -571 series VDS-DCX/DC [Digimatic Scale Unit] -572 series SD-D/SDV-D [Digimatic Exclusive Caliper] -573 series Models with suffix CX/C	[Surface Roughness Tester] -178 series SJ-201/210/301/400 [Coating Thickness Gage] -179 series DGE-745/755 [Linear Height] -518 series QMH-S [Reference Gage] -515 series HMD-C [Digimatic Indicator] -543 series ID-H/F [Laser Scan Micrometer] -544 series LSM-9506/6100/6200/6900 [μ-checker] Digital μ-checker (Using the foot switch)	[Digimatic Micrometer] -121 series BD -164 series MHD-M/AX -227 series CLM -293 series MDQ-M MDC-M [Tubular Inside Micrometer] -337 series IMZ-M [Tubular Inside Micrometer] -339 series IMJ-M [Digimatic Holtest] -468 series HTD [Reference Gage] -515 series HME-DM [Borematic] -568 series SBM-C [Hardness Testing Machines] -810 series HM-100/200 HV-100/HH-411 HR-500	[Digimatic Height Gage] -192/570/574 series HDM-A/AX, HD-A/AX HDS-H_C/C HDF-N [Digimatic Caliper] -500/550/551 series CD/CDC/CDN [Digimatic Bore Gage] -511 series CG-D [Digimatic Indicator] -543 series ID-C_X/_RB/_GB ID-C/S/C_A [Digimatic Depth Gage/Digimatic Thickness Gage] -547 series Digimatic model (ID-C/CX) [Digimatic Carbon Fiber Caliper] -552 series CFC-P/_L/_C/_U [Digimatic Scale Unit] -572 series SD-E, SDV-E SD-F, SDV-F [Portable Hardness Testing Instruments] -811 series HH-300	[Digimatic Indicator] -543 series ID-N ID-B
Measuring instruments that cannot be connected					[Surface Roughness Tester] -178 series SJ-500 [Linear Gage/Counter] -542 series EF-PRH/ZR, EH-P/Z/S/D EB-P/Z/D EC-D [Litematic] -318 series VL-A/AS/AH			
Reference: Order No. of wiretype connecting cable	1m	05CZA624	05CZA662	959149	936937	937387	905338	21EAA194
	2m	05CZA625	05CZA663	959150	965014	965013	905409	21EAA190

Combination with application systems

Measurement Data Network System — MeasurLink 8 Real-Time / Professional

When data is input, **MeasurLink** displays a variety of statistical processing results including GO/NG judgment, process capability, Xbar-R control chart and histogram on the screen in real time.

For details, refer to **MeasurLink Catalog No. PRE1388(2)**

Measuring tool B ID=01

Measuring tool C ID=99

Measuring tool A ID=00

U-WAVE's New Function (Common): Data Cancellation Function Activated by holding down the button

Release the button when the **U-WAVE-T** LED starts blinking orange.

Hold down the DATA button for two seconds or longer.

Standing details can be freely selected.

- Character information (item information and calculation result)**
Item name, measured value, error value, upper/lower limits, Cp, Cpk, Pp, Ppk, standard deviation, average, maximum value, minimum value, defect rate, etc. (All selectable)
- Chart display (control charts, etc.)**
Xbar-R control chart, Xbar-S control chart, X-Rs control chart, histogram, tear chart, run chart, pre-control chart, statistics, etc. (All selectable)
- Color-coding of judgment of GO/NG results**
The color of the outer frame of the call-out corresponds to the GO/NG result.

Green	Yellow	Red
OK	Close to out-of-tolerance	Out-of-tolerance

Detailed statistical charts can be arbitrarily displayed.

- Individual item chart**
 - Xbar-R control chart (a)
 - Xbar-S control chart
 - X-Rs control chart
 - EWMA control chart
 - Histogram (b)
 - Run chart
 - Pre-control chart (c)
 - Tear chart
- All item chart**
 - Multivariate control chart
 - Column indicator
 - All item Cpk sheet
 - Multivariate defect ratio (bar graph)
 - Manager display (4 columns x 3 rows) (Histogram, meter, box and whisker plot, Cpk)
- Measured value**
 - Measured value data sheet
 - Parts data sheet
- Statistics**
 - Maximum value
 - Minimum value
 - Average
 - Standard deviation S, Rbar/d2
 - Process capability Cp, Cpk, Pp, Ppk
 - Defect ratio
 - Average $\pm 3\sigma/4\sigma/6\sigma$ etc.

Other specifications

- Alarm function: tolerance judgment, control limit value, series, tendency, etc.
- Report output: statistical calculation result, chart, measured value, etc.
- Comment addition and per-layer function: It is possible to add history information (such as inspector, machine tool, lot number, serial number, and cause of failure) to data as comment so that it can be checked when a problem occurs or used as a keyword to search for or narrow down data.
- File import function: Text, PocketDL or other file
- File output: Excel, text or other format

Association between U-WAVE-T ID and the measured item

When there is a one-to-one relationship between the measuring tool and the measured item, data randomly measured by the operator can be automatically input into the associated measured item.

When a single measuring tool measures multiple items, determine the measurement order in advance since a single ID cannot identify measured items.

When V6.0 or earlier version is used

When using an older version, it is necessary to upgrade to V6.1 to support data cancellation and other new functions in **U-WAVE**. In V6.0, data can be input in the USB input tool mode with the data interface function (identification by ID is not supported).

Combining this product with commercially available quality control software allows creation of statistical processing and inspection tables. New functions including U-WAVE ID identification and data cancellation have been added.

Combination with application systems

Central management of quality information through construction of measurement data network system

MeasurLink can be expanded to a network system of server and clients. This software consolidates and centrally manages measurement data generated across the factory (handheld measuring tools to CMMs) to support quality information sharing.

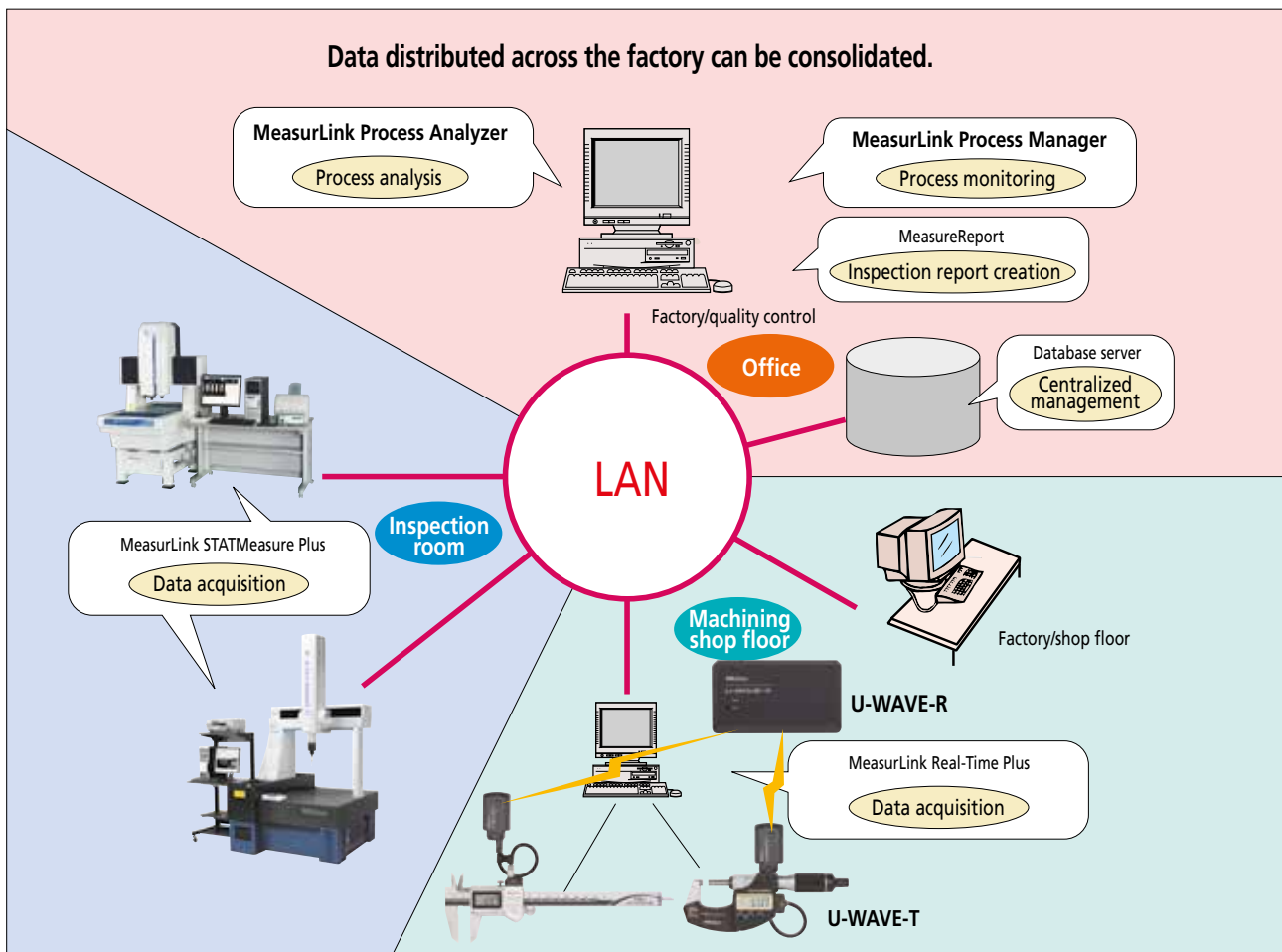

Operating environment (recommended)

MeasurLink 8 Real-Time / Professional

- OS: All Windows 7 and 8 versions / 32-bit and 64-bit supported
- CPU: Pentium II 400 MHz or higher
- Memory: 512 MB or more
- Hard disk: 10 GB or more free space
- I/O: USB port (required for **U-WAVE-R** connection)
- Media drive: CD-ROM (required at installation)
- Other specifications: keyboard and mouse

MeasurLink Real-Time Data Collection Module

Features

MeasurLink Real-Time enables you to connect and acquire data from virtually any measuring device. It supports the full range of metrology technology, including calipers, micrometers, indicators, CMMs, vision systems and more. Select the edition to fit the device and your needs.

Real-Time Professional Edition

Enables customers to connect and acquire data from Mitutoyo Coordinate Measuring Machines, Vision and Form Measuring Systems via native integration (DDE). ASCII and QMD (xml-based) file import are also supported. In addition to the features above, this application also includes data filters and a full reporting tool complete with sample templates.

Supported data sources: keyboard, RS-232C and USB devices, native Mitutoyo integration (DDE), ASCII and QMD (xml-based) file import.

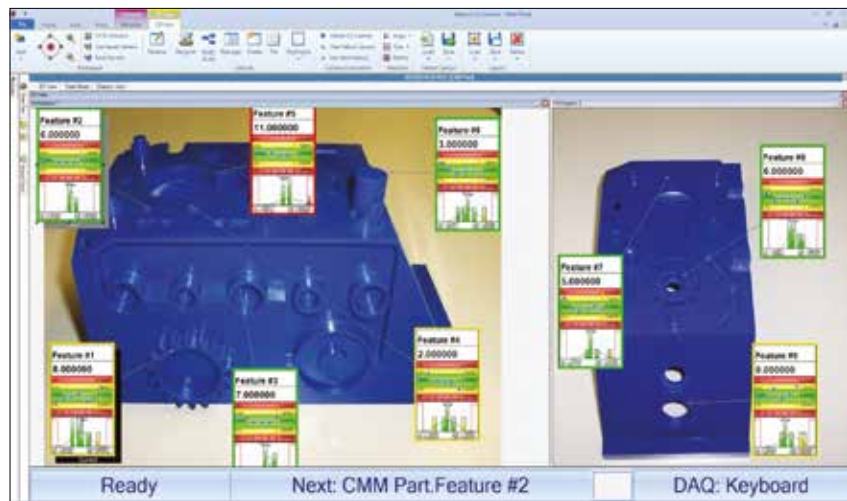

SPECIFICATIONS

Order No.	Description
64AAB471R	MeasurLink 8 Real-Time Professional Edition

Note: Upgrade packages are also available. Please contact our sales department for details.

Import templates

Easily create an import template that maps data in a text file to MeasurLink. Templates are saved to the database for everyone to use and can be added as data sources to data collection stations. An import template can be verified against the source file without adding data to the system.

Direct data transfer

Collect data into MeasurLink from Mitutoyo measuring systems running Mitutoyo software that is MeasurLink enabled. This provides a tighter and more robust interface than importing data from files.

Filter data

All data collected within a Real-Time run is related. Often, especially for runs containing a large volume of subgroups, requests are made for subsets of data that are further related to the entire run's population. MeasurLink provides robust filtering capabilities to comply with these requests.

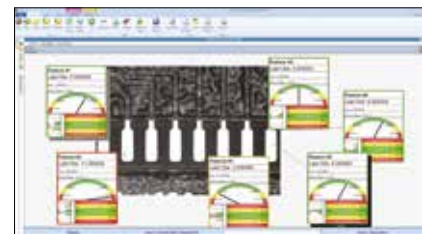

Import data

When set up as a data source, import templates are readily available to the operator; or periodic imports can be executed.



**Whatever your challenges are,
Mitutoyo supports you from start to finish.**

Mitutoyo is not only a manufacturer of top quality measuring products but one that also offers qualified support for the lifetime of the equipment, backed up by comprehensive services that ensure your staff can make the very best use of the investment.

Apart from the basics of calibration and repair, Mitutoyo offers product and metrology training, as well as IT support for the sophisticated software used in modern measuring technology. We can also design, build, test and deliver bespoke measuring solutions and even, if deemed cost-effective, take your critical measurement challenges in-house on a sub-contract basis.



**Find additional product literature
and our product catalogue**

www.mitutoyo.eu

Note: Product illustrations are without obligation. Product descriptions, in particular any and all technical specifications, are only binding when explicitly agreed upon. MITUTOYO and U-WAVE are either registered trademarks or trademarks of Mitutoyo Corp. in Japan and/or other countries/regions. Excel, Microsoft, and Windows are either registered trademarks or trademarks of Microsoft Corporation in the United States and/or other countries.

Other product, company and brand names mentioned herein are for identification purposes only and may be the trademarks of their respective holders.

Mitutoyo

Mitutoyo Europe GmbH

Borsigstraße 8-10
41469 Neuss

Tel. +49 (0) 2137-102-0

Fax +49 (0) 2137-102-351

info@mitutoyo.eu

www.mitutoyo.eu