

QUICK VISION SERIES

CNC VISION MEASURING SYSTEM



Quick Vision – perfect solutions for any purpose

With sophisticated edge detection capabilities, an illumination wizard and advanced, user-friendly software the Quick Vision Series satisfies the demand for compactness, high accuracy and vast performance in the field of non-contact dimensional measurement.

Continuous evolution

Mitutoyo has been selling CNC vision measuring machines - including the Quick Vision Series - since the mid-1980s and is proud of its superb delivery record.

Today measurement professionals bear high demands. High accuracy, perfect ease of use and small dimensions are only three of many virtues they expect. Mitutoyo has recently relaunched the well-renowned Quick Vision Series to address such demands. The new Quick Vision Series perfectly integrates the advanced optical, sensing, software and vision measuring technologies which Mitutoyo has developed to help customers solve the challenges they face.

Traceability

In Japan Mitutoyo is the only domestic company accredited to provide a calibration service for the three main types of length standard (laser sources, end standards, and line standards). Also, being the manufacturer of the most comprehensive range of precision measuring instruments available, Mitutoyo offers a number of measuring instruments traceable to national standards, such as coordinate measuring machines, optical measuring instruments, and form measuring instruments, as well as vision measuring machines.



Production of linear scales



Iodine absorption stabilised He-Ne (633 nm) laser for length measurement



Design and production of lenses

Software

Knowledge-based software to Control Quick Vision

QVPAK is a software package that is constantly enhanced. In combination with various other applications, QVPAK delivers multifunctional analysis along with high-speed processing and simple operation.



Kawasaki plant (Japan)

Optical

The optical system employed in the Quick Vision Series is based on optical technology that Mitutoyo has acquired over many years. This is a practically ideal optical system with the image flat across the field of view with little flare.



Quick Scope



Functionality

Lineup of vision measuring systems

Accuracy ↑



ULTRA Quick Vision



M-NanoCoord



Quick Vision Apex
Hyper Quick Vision



UMAP Vision System



Hyper Quick Vision WLI



Quick Vision ELF



Quick Vision ACCEL

Enhanced functionality by multi-probe use – the ideal solution to meet the customer's needs

Touch-trigger probe

Quick Vision Series models can also use touch-trigger probes to support the measurement of workpiece features that cannot be inspected with vision alone. This capability is also useful when extremely precise height measurement is required.



Magnified vision

A magnified image is taken by a CCD camera, and then dimensional measurements can be performed by way of edge detection and auto-focus, which use image processing technology.



Laser probe

Utilising this non-contact displacement sensor that uses a laser focusing point method, the Quick Vision Series can use its scanning function to measure very small steps and curved planes at high speed.

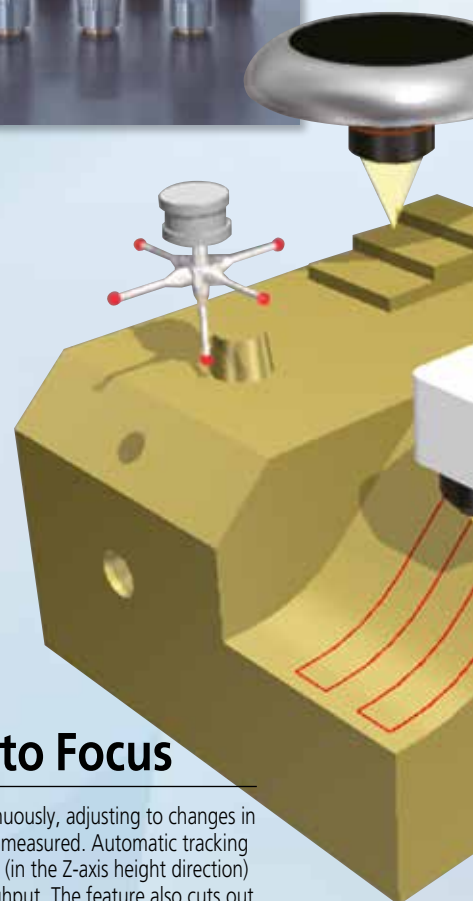
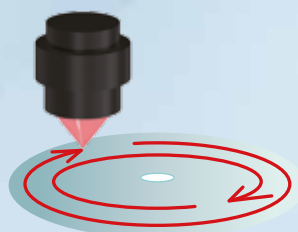
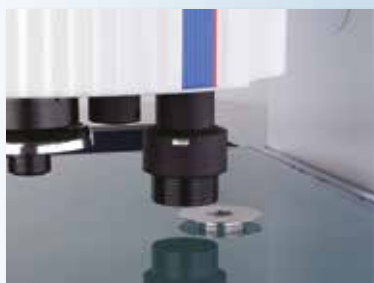

CPS probe

Thanks to its wavelength confocal format, non-contact displacement sensor that uses the epaxial chromatic aberration of the white light source, the Quick Vision Series can use its scanning function to measure very small steps and curved planes at high speed.

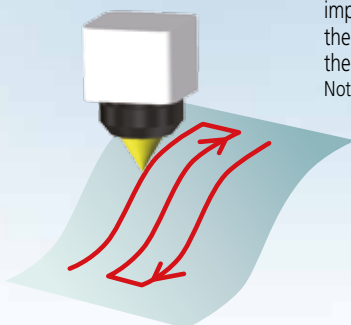

Tracking Auto Focus

The TAF feature focuses continuously, adjusting to changes in the height of the object being measured. Automatic tracking of surface waves and warpage (in the Z-axis height direction) improves measurement throughput. The feature also cuts out the hassle of focusing during manual measurement, reducing the workload for measuring system operators.

Note: Continuous measurement of displacement is not performed.

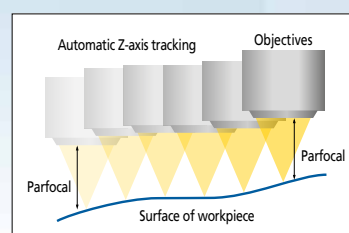

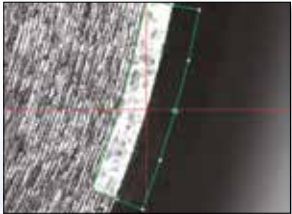

Image edge detection using a filter



Highly accurate height measurement thanks to image auto-focus

UMAP probe

By using an extremely small stylus with a high aspect ratio, made possible by our proprietary sensing technology, the Quick Vision Series can perform contact measurements on small or narrow parts.

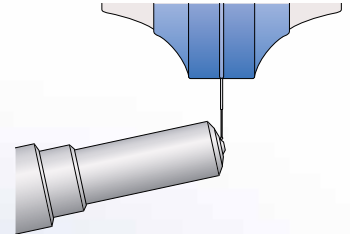

Measurement of a fuel injection nozzle hole's shape

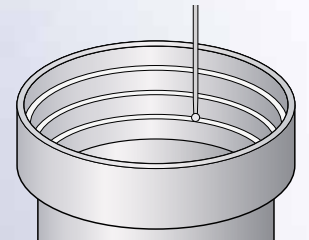

Measurement of a lens barrel's shape

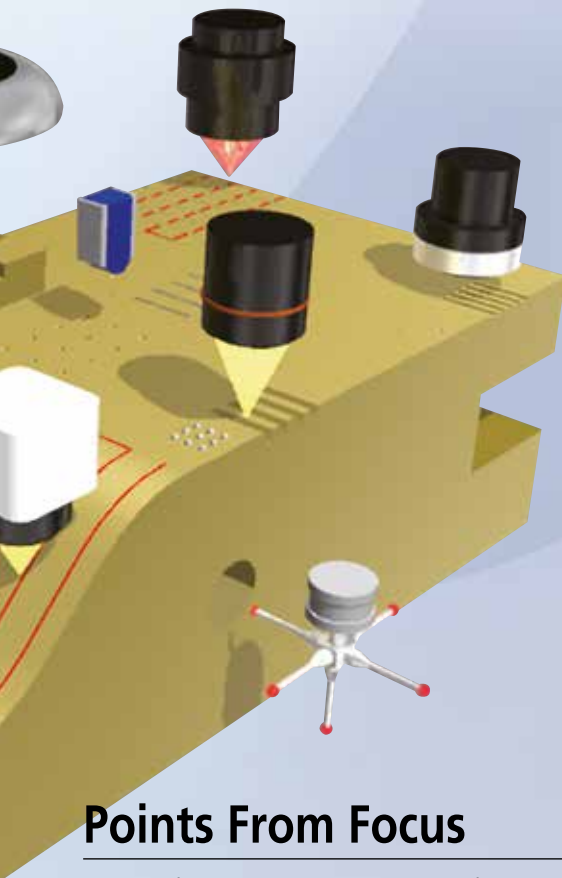

White Light Interferometer

Using its white light interferometer, the Quick Vision Series can perform highly accurate 3D measurements in microscopic areas for surface analysis, small-diameter hole depth, and line as well as space measurements on circuit boards.

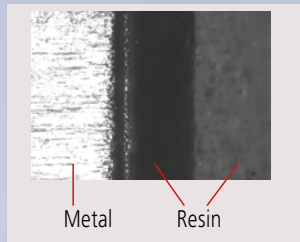

Metal Resin



Points From Focus

Contrast information can be used to obtain 3D form data from images at different heights that have been taken by the Quick Vision Series.

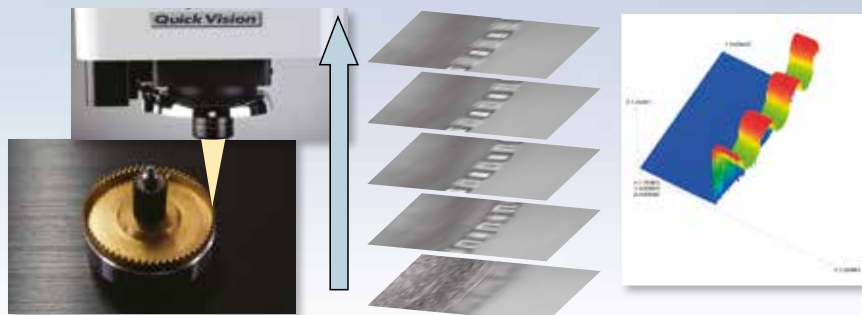

QV Index

Using the QV index to rotate the workpiece makes it possible to automatically measure multiple surfaces without having to dismount/remount the workpiece.

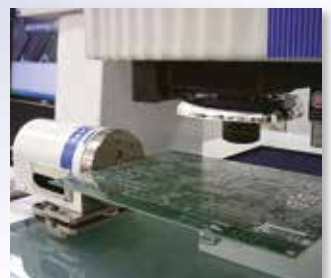

Main unit structure enables high-accuracy and high-performance 3D non-contact measurements

Quick Vision Series features

The Quick Vision Series is a non-contact dimension measurement system. It uses its CCD camera to take images magnified by its optical lens, and then uses image processing technology to detect the edges of the workpiece.

- The dimensions of microscopic features can be measured because the Quick Vision Series performs measurements on images that have been strongly magnified by its optical system. The Quick Vision Series is extremely well-suited to measurements of microscopic workpieces as found in electronics, semiconductor components, precision machinery and medical equipment components.
- Because the Quick Vision Series performs non-contact measurements, there is no risk of the workpiece being damaged, deformed or stained. In addition to measurements of electronic and semiconductor components that must be kept clean, the Quick Vision Series is also suited to measurements of workpieces such as soft resin-molded products and thin press-molded products.
- The Quick Vision Series can perform high-speed measurements of multiple points within the captured image. The image processing technology and high-speed stage control enable high-throughput measurements, which makes the Quick Vision Series the optimal solution for workpieces that have many features to be measured and for manufacturing process management of mass-produced products.
- The Quick Vision Series uses its image auto focus function and non-contact displacement sensor to perform highly accurate height measurements.

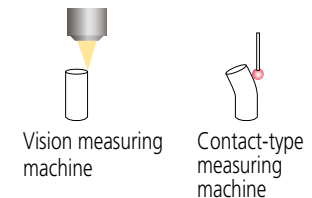
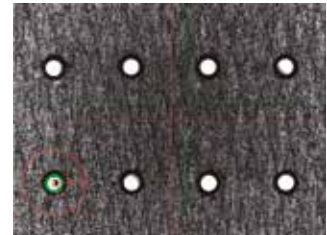

Main unit structure optimised for highly accurate measurements

Structural deformation caused by movement along each axis has been minimised, which ensures that the Quick Vision Series can be used to perform highly accurate measurements with minimal spatial coordinate distortions.

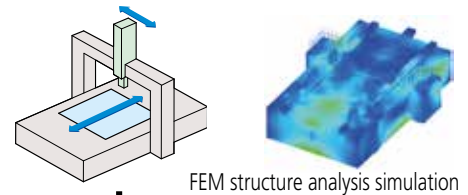

Lineup offers choice of measuring range and accuracy

The QV Series consists of a diverse lineup that includes models ranging from compact to large-range models and from models with general-purpose accuracy to such with extremely high accuracy. The QV series can meet all the varied measurement needs for manufacturing industry.

Name	Size	Measurement range (mm)
QV ELF	202	250x200x200
QV Apex	302	300x200x200
Hyper QV	404	400x400x250
QV STREAM PLUS	606	600x650x250
	808	800x800x150
QV ACCEL	1010	1000x1000x150
	1212	1250x1250x100
	1517	1500x1750x100

Highly functional and versatile illumination unit

- QV-PROs use LEDs for all of their light sources: contour, surface, and programmable ring light.
- Lighting uniformity has been achieved at a high level, which leads to excellent part program compatibility between multiple QVs.
- LED light sources boast excellent responsiveness, which improves measurement throughput.
- LED light sources have longer live expectancy than halogen types. They reduce illumination fluctuations and thereby minimise any errors caused by changes in light intensity.

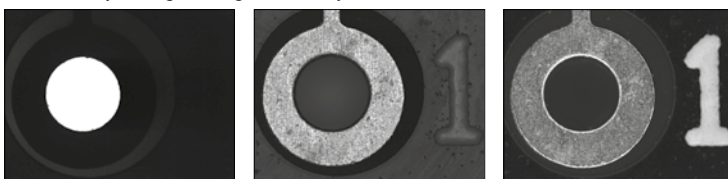

Contour illumination Vertical surface illumination Programmable ring light illumination

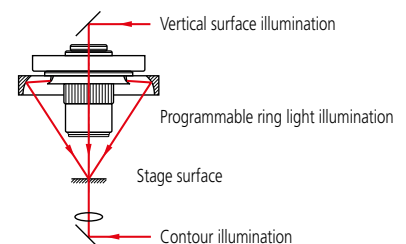

Highly functional lighting for positive edge detection and automatic measurements

Programmable Ring Light (PRL)

Changing the positions of the two curved mirrors sets the ring light's obliquity to any chosen value between 30° and 80°. This is effective for enhancing the edges of inclined surfaces or very small steps.

Furthermore, the PRL light's illumination can be controlled independently in every direction, front and back, right and left. This makes it possible to configure highly variable lighting settings to match measurement locations.



Measuring the top and bottom widths of metallisation patterns on an IC package

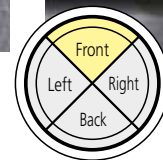
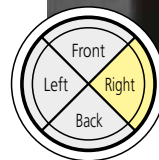
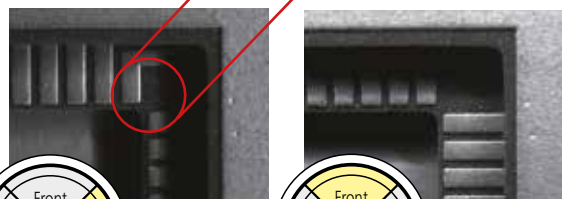
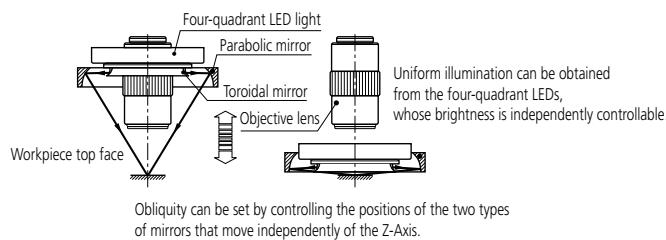
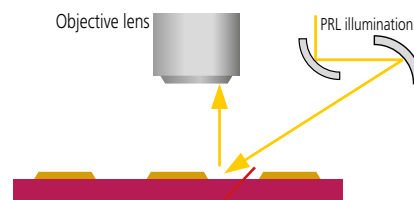

Tracking Auto Focus (TAF)

The TAF feature focuses continuously, adjusting to changes in the height of the object being measured. Automatic tracking of surface waves and warpage (in the Z-axis height direction) improves measurement throughput. The feature also cuts out the hassle of focusing during manual measurement, reducing the work burden for measuring system operators.

Note: Continuous measurement of displacement is not performed.

Laser source	Semiconductor laser (peak wavelength: 690nm)				
Laser safety	Class 2 (JIS C6802:2011, EN/IEC 60825-1:2007)				
Autofocus system	Objective coaxial autofocusing (knife-edge method)				
Applicable objectives	QV-HR1X	QV-SL1X	QV-HR2.5X	QV-SL2.5X	QV-5X
Tracking range *	6.3mm (±3.15mm)	6.3mm (±3.15mm)	1mm (±0.5mm)	1mm (±0.5mm)	0.25mm (±0.125mm)

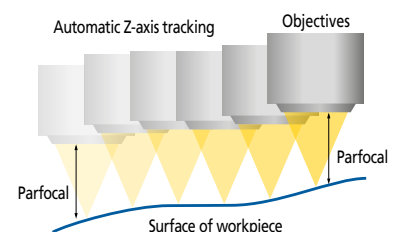

* When using Tracking Auto Focus, be sure to set upper and lower limits in the software to prevent collisions between the objective and the workpiece. The tracking range depends on the surface texture and reflectance of a workpiece.

Vast flexibility: powerful vision sensor boasting Mitutoyo's high performance lenses

Programmable power turret

The QV's programmable power turret has excellent magnification repeatability which makes it suitable for highly accurate measurements. Furthermore, the rich lineup of objectives contains lenses with magnifications ranging from 0.5X to 25X, which makes it possible to select the optimal optical system to match the measurement target. It is easy to install new objective lenses by using the optional calibration chart and compensation chart, so additional objectives can be purchased at a later date.



Various objective lenses for the QVs

Objective lenses

QV-HR1X



PPT1X
Field of view: 6.27 x 4.70 mm



PPT2X
Field of view: 3.13 x 2.35 mm



PPT6X
Field of view: 1.04 x 0.78 mm

QV-HR2.5X



PPT1X
Field of view: 2.49 x 1.86 mm



PPT2X
Field of view: 1.24 x 0.93 mm

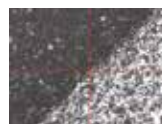

PPT6X
Field of view: 0.41 x 0.31 mm

QV-5X



PPT1X
Field of view: 1.24 x 0.93 mm



PPT2X
Field of view: 0.62 x 0.47 mm



PPT6X
Field of view: 0.20 x 0.15 mm

QV-HR10X



PPT1X
Field of view: 0.62 x 0.47 mm



PPT2X
Field of view: 0.31 x 0.23 mm



PPT6X
Field of view: 0.10 x 0.07 mm

	Monitor magnification*1,*3	15X	29X	58X	72X	87X	144X	173X	290X	430X	580X	720X	870X	1440X	1730X	4300X
	Field of view (mm)	12.54x9.4	6.27x4.7	3.13x2.35	2.49x1.86	2.09x1.56	1.24x0.93	1.04x0.78	0.62x0.47	0.41x0.31	0.31x0.23	0.25x0.18	0.20x0.15	0.12x0.09	0.10x0.07	0.04x0.03
PRO model programmable power turret	0.5X objective lens	●	●	●	●	●	●	●	●	●	●	●	●	●	●	●
	1X objective lens		●	●	●	●	●	●	●	●	●	●	●	●	●	●
	2.5X objective lens			●	●	●	●	●	●	●	●	●	●	●	●	●
	5X objective lens				●	●	●	●	●	●	●	●	●	●	●	●
	10X objective lens*2					●	●	●	●	●	●	●	●	●	●	●
25X objective lens*2						●	●	●	●	●	●	●	●	●	●	

*1: With QVPAK version 10 or later, the size of the video window can be changed. Monitor magnification shown in the above table is a reference value at the same display magnification when using 56 cm / 22-inch wide LCD monitor.

*2: When the 10X objective lens or 25X objective lens is used in combination with the 2X or 6X magnification of the power turret, the brightness may be insufficient depending on the workpiece.

*3: For the PRO3 models, the monitor magnifications are 1.34 times and the field of view are approximately 0.75 times those of the PRO model.

Colour camera specifications that improve the observation function (PRO3 model)

To improve the observation function, Mitutoyo offers the PRO3 model that is equipped with a colour CCD camera.

A high-resolution CCD camera has been used to achieve the specifications of the PRO3, so highly accurate measurements without decrease in the resolution of the screen can be performed.

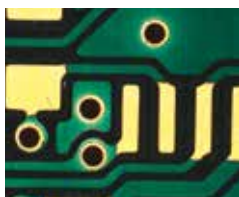

Printed circuit board



QFP package leads

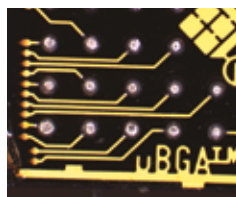

IC package



LCD colour filter



Resin-molded product

High-performance multi-autofocus

The QV Series is equipped with a high-performance image autofocus function as standard. Image autofocus is used to assure accuracy. Thanks to the availability of various autofocus tools, the optimal focus for each surface texture and measured feature can be selected, which makes it possible to perform highly reliable height measurements. Furthermore, the autofocus operates at high speed, which increases total measurement throughput.

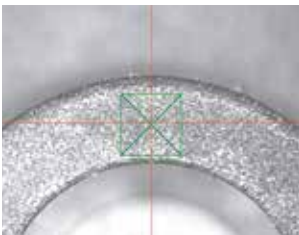

Surface focus

Image autofocus can be used to measure the height of a chosen area, which makes it possible to perform stable height measurements that are minimally affected by the roughness of machined and other similar surfaces.

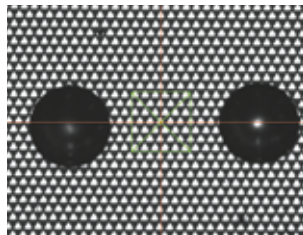

Pattern focus

Autofocus can be performed on low-contrast transparent objects, such as film, glass and mirrored surfaces by projecting onto the object surface a pattern placed within the light path.

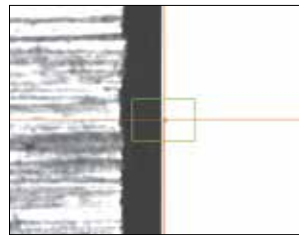

Edge focus

Edge focus is suited to focusing edges that have been chamfered or that have a corner radius. Using this focus tool prior to performing edge detection improves edge detection reproducibility.

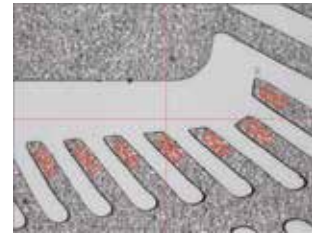

Multi-point autofocus

Multi-point autofocus can be used to set multiple focus positions, sizes, and angles to arbitrary values. This tool can be used to obtain multiple sets of height information with a single focus operation, which makes it possible to perform highly efficient height and flatness measurements.



Resin-molded product



IC package



Chamfered part of a machined surface



Accuracy conforming to ISO10360-7

The accuracy specifications of some models in the Quick Vision Series are conforming to ISO10360-7. Contact Mitutoyo for details on applicable models.

Guaranteed accuracies

- Length measurement error
- Probing error

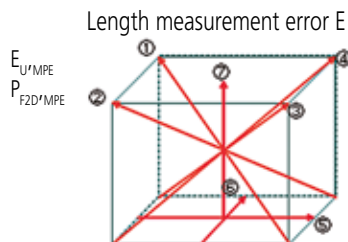

Multi-function control box

This multi-function control box was developed for maximum ease of use.

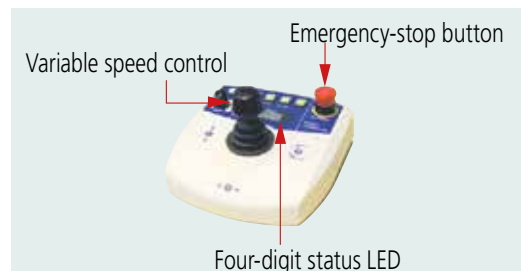

Compact CNC vision measuring system QV ELF



QV ELF

QV ELF

- The edge detection capability and the functions of the measurement software QVPAK are as powerful as those of the higher model QV Apex. This enables the QV ELF to surpass the conventional image of a compact model.
- While the QV ELF is a compact model, it has a more than adequate Z-Axis stroke of 200 mm.
- Each lighting unit employs long-life white LEDs with low power consumption. The LED light sources boast excellent responsiveness, which improves measurement throughput.
- This model can support ISO10360-7:2011 guaranteed accuracy (specifications on request).

Specifications

Model	QV ELF	
Optical system	PRO	
Order No.	363-1075Y	
Measuring range (X×Y×Z)	250×200×200mm	
Resolution of scale / Scale type	0.1μm / linear encoder	
Observation unit *1	PPT1X -2X -6X	
Imaging device	B&W CCD	
Illumination unit	Co-axial light	White LED
	Transmitted light	White LED
	PRL	White LED
Accuracy *2	E _{1X} , E _{1Y}	(2+3L/1000)μm
	E _{1Z}	(3+5L/1000)μm
Operating temperature range	Ambient temperature	20±1°C
	Temperature variation	2°C/8H
Stage glass size	311×269mm	
Maximum stage loading *3	15kg	
Main unit external dimensions	586×847×1528mm	
Main unit mass (including the sub-base)	270kg	

*1 The specific combination of 1X, 2X and 4X or 1X, 2X, 4X and 6X is available by custom order.

*2 Determined by Mitutoyo's inspection method. L is the measured length (mm).

The optical condition for accuracy assurance is to be (QV-HR2.5X or QV-SL2.5X) + Middle magnification of the tube lens.

*3 An excessively biased or concentrated load is excluded.

* The Laser Auto Focus (LAF) specification is available by custom order.

Standard CNC vision measuring system

QV Apex



QV Apex 302PRO

QV Apex

- QV Series standard models range from compact to large in size.
- A model equipped with the tracking focus function that allows continuous focusing in response to change in workpiece height is also available. This results in improved measurement throughput.
- The lineup, including the PRO3 models equipped with a color CCD camera, can satisfy a wide range of demands.
- The QV Apex 404 and QV Apex 606 X-Axis and Y-Axis drive speeds reach 400 mm/second. This greatly contributes to throughput improvement, particularly for workpieces that involve a large range of travel.
- The accuracy of this model (PRO type only) is conforming to ISO10360-7:2011 (specifications on request)

Specifications

Model	QV Apex 302				QV Apex 404				QV Apex 606			
	PRO		PRO3		PRO		PRO3		PRO		PRO3	
Optical system	—		●		—		●		—		●	
Tracking Auto Focus device	—		●		—		●		—		●	
Order No.	363-170SY	363-174SY	363-171Y	363-175Y	363-180SY	363-184SY	363-181Y	363-185Y	363-190SY	363-194SY	363-191Y	363-195Y
Measuring range (X×Y×Z)	300×200×200mm				400×400×250mm				600×650×250mm			
Resolution of scale / Scale type	0.1μm/Linear Encoder											
Observation Unit*1	PPT1X-2X-6X											
Imaging Device	B&W CCD		3CCD Color		B&W CCD		3CCD Color		B&W CCD		3CCD Color	
Illumination Unit*2	Co-axial light				White LED							
	Transmitted Light				White LED							
	PRL				White LED							
Accuracy*3	E _{1X} , E _{1Y}				(1.5+3L/1000)μm							
	E _{1Z}				(1.5+4L/1000)μm							
	E _{2XY}				(2+4L/1000)μm							
Operating Temperature range	Ambient temperature				20±1°C							
	Temperature variation				2°C/8H							
Stage glass size	399×271mm				493×551mm				697×758mm			
Maximum stage loading*4	20kg				40kg				50kg			
Main unit external dimensions	859×951×1609mm				1027×1407×1778mm				1309×1985×1794mm			
Main unit mass (including the sub-base)	360kg				579kg				1450kg			

*1 The specific combination of 1X, 2X and 4X or 1X, 2X, 4X and 6X is available by custom order.

*2 The color LED lighting or halogen lighting specification is available by custom order.

*3 Determined by Mitutoyo's inspection method. L is the measured length (mm).

The optical condition for accuracy assurance is to be (QV-HR2.5X or QV-SL2.5X) + Middle magnification of the tube lens.

*4 An excessively biased or concentrated load is excluded.

* The Laser Auto Focus (LAF) specification is available by custom order.

High-accuracy CNC vision measuring system Hyper QV



Hyper QV 404PRO

Hyper QV

- The Hyper QV is a highly accurate model that is equipped with a high-resolution/accuracy scale.
- A lineup, similar to the QV Apex, containing models that range in size from compact to large means that a model ideally suited to the size of the workpiece can be selected.
- The model equipped with the tracking focus function that allows continuous focusing in response to change in workpiece height is also available. This results in improved measurement throughput.
- This model is standard-equipped with an automatic temperature compensation function that uses a temperature sensor on the main unit of the measuring machine and a temperature sensor for the workpiece, thus guaranteeing the stated accuracy specification applies over the temperature range 18 to 23°C for stable measurement results.
- The accuracy of this model is conforms to ISO10360-7:2011 (specifications on request).

Specifications

Model	Hyper QV 302		Hyper QV 404		Hyper QV 606	
Optical system	PRO					
Tracking Auto Focus device	—	●	—	●	—	●
Order No.	363-173SY	363-177SY	363-183SY	363-187SY	363-193SY	363-197SY
Measuring range (X×Y×Z)	300×200×200mm		400×400×250mm		600×650×250mm	
Resolution of scale / Scale type	0.02μm/linear encoder					
Observation unit *1	PPT1X-2X-6X					
Imaging device	B&W CCD					
Illumination unit *2	Co-axial light		White LED			
	Transmitted light		White LED			
	PRL		White LED			
Accuracy *3	E _{1X} , E _{1Y}		(0.8+2L/1000)μm			
	E _{1Z}		(1.5+2L/1000)μm			
	E _{2XY}		(1.4+3L/1000)μm			
Operating temperature range	Ambient temperature		18 ~ 23°C			
	Temperature variation		0.5°C / 1H and 1°C / 24H			
Stage glass size	399×271mm		493×551mm		697×758mm	
Maximum stage loading *4	15kg		30kg		40kg	
Main unit external dimensions	859×951×1609mm		1027×1407×1778mm		1309×1985×1794mm	
Main unit mass (including the sub-base)	360kg		579kg		1450kg	
Temperature compensation function	automatic					

*1 The specific combination of 1X, 2X and 4X or 1X, 2X, 4X and 6X is available by custom order.

*2 The color LED lighting or halogen lighting specification is available by custom order.

*3 Determined by Mitutoyo's inspection method. L is the measured length (mm).

The optical condition for accuracy assurance is to be (QV-HR2.5X or QV-SL2.5X) + Middle magnification of the tube lens.

*4 An excessively biased or concentrated load is excluded.

* The Laser Auto Focus (LAF) specification is available by custom order.

Non-stop CNC vision measuring system

QV STREAM PLUS



QV STREAM PLUS

• The QV STREAM PLUS is an innovative vision measuring machine that acquires images without stopping the stage. This is accomplished by synchronizing the main unit's X-Axis and Y-Axis traversal with strobe illumination. Conventional vision measuring machines repeat the displacement, stop, measurement, and displacement cycle, which restricts throughput. In contrast, the QV STREAM PLUS realizes non-stop vision measurement (stream mode) by eliminating acceleration, deceleration, and stop times. Consequently, this dramatically reduces the overall measurement time.

- The model equipped with the tracking focus function that allows continuous focusing in response to change in workpiece height is also available. This results in improved measurement throughput.
- The lineup is similar to the QV Apex range. The models range in size from compact to large. Hence, there is always one that ideally suits the workpiece to be measured.

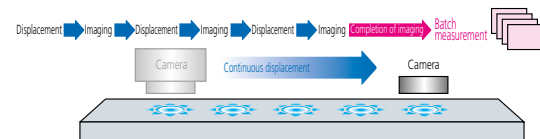

Specifications

Model	QV STREAM PLUS 302		QV STREAM PLUS 404		QV STREAM PLUS 606	
Optical system	PRO					
Tracking Auto Focus device	—		●		—	
Order No.	363-172Y	363-176Y	363-182Y	363-186Y	363-192Y	363-196Y
Measuring range (XxYxZ)	300x200x200mm		400x400x250mm		600x650x250mm	
Resolution of scale / Scale type	0.1μm/linear encoder					
Observation unit*1	PPT1X-2X-6X					
Imaging device	B&W CCD					
Illumination unit*2	Co-axial light*3	Color LED				
	Transmitted light	Blue LED				
	PRL*3	Color LED				
Accuracy*4	E _{1X} , E _{1Y}	(1.5+3L/1000)μm				
	E _{1Z}	(1.5+4L/1000)μm				
	E _{2XY}	(2+4L/1000)μm				
Operating temperature range	Ambient temperature	20±1°C				
	Temperature variation	2°C/8H				
Stage glass size	399x271mm		493x551mm		697x758mm	
Maximum stage loading*5	20kg		40kg		50kg	
Main unit external dimensions	859x951x1609mm		1027x1407x1778mm		1309x1985x1794mm	
Main unit mass (including the sub-base)	360kg		579kg		1450kg	

*1 The specific combination of 1X, 2X and 4X or 1X, 2X, 4X and 6X is available by custom order.

*2 Only one of the illumination functions (reflected, transmitted, and PRL illumination) can be set in STREAM mode. The 4-way PRL illumination can be set to the entire lighting (4-direction lighting) or single-direction lighting.

*3 Enable to use cyan only while using STREAM mode.

*4 Determined by Mitutoyo's inspection method. L is the measured length (mm).

The optical condition for accuracy assurance is to be (QV-HR2.5X or QV-SL2.5X) + Middle magnification of the tube lens.

*5 An excessively biased or concentrated load is excluded

* The Laser Auto Focus (LAF) specification is available by custom order.

Large CNC vision measuring system

QV ACCEL



QV ACCEL

- The QV ACCEL is a moving-bridge type. Because the stage remains stationary, the fixtures used to hold workpieces in place can be simplified. This leads to a reduction in the amount of work required to create these fixtures. In addition, the QV ACCEL is suited to measurements of workpieces that have short life cycles and to measurements of thin and light-weight workpieces.
- The QV ACCEL is optimal for measurements of printed circuit boards, whose density and resolution continue to increase, as well as metal masks and screen plates. The QV ACCEL is also optimal for measurements on glass circuit boards, film, and other components of display panels.
- By using highly functional edge detection and image auto focus, the QV ACCEL can perform highly accurate height measurements. The QV ACCEL is standard-equipped with a pattern focus function that can be used to perform image auto focusing even on transparent objects such as film and glass.
- The model equipped with the tracking focus function that allows continuous focusing in response to change in workpiece height is also available. This results in improved measurement throughput.

Specifications

Model	QV ACCEL 808		QV ACCEL 1010		QV ACCEL 1212		QV ACCEL 1517		
Optical system	PRO	PRO3	PRO	PRO3	PRO	PRO3	PRO	PRO3	
Standard machine	363-315Y	363-316Y	363-335Y	363-336Y	363-355Y	363-356Y	363-375Y	363-376Y	
Tracking Auto Focus device	363-321Y	363-322Y	363-341Y	363-342Y	363-361Y	363-362Y	363-381Y	363-382Y	
Measuring range (X×Y×Z)	800×800×150mm		1000×1000×150mm		1250×1250×100mm		1500×1750×100mm		
Resolution of scale / Scale type	0.1 μm/linear encoder								
Observation unit *1	PPT1X-2X-6X								
Imaging device	B&W CCD	Color CCD	B&W CCD	Color CCD	B&W CCD	Color CCD	B&W CCD	Color CCD	
Illumination unit *2	Co-axial light	White LED							
	Transmitted light	White LED							
	PRL	White LED							
Accuracy *3	E _{1X} , E _{1Y}	(1.5+3L/1000) μm				(2.2+3L/1000) μm			
	E _{1Z}	(1.5+4L/1000) μm				(2.5+5L/1000) μm			
	E _{2XY}	(2.5+4L/1000) μm				(3.5+4L/1000) μm			
Repeatability *3	Short dimension	3σ=0.2 μm				3σ=0.2 μm			
	Long dimension	3σ=0.7 μm				3σ=1.5 μm			
Operating temperature range	Ambient temperature	20±1°C							
	Temperature variation	2°C/8H							
Stage glass size	883×958mm		1186×1186mm		1440×1440mm		1714×1968mm		
Maximum stage loading *4	10kg		30kg		30kg		30kg		
Main unit external dimensions	1475×1860×1578mm		1912×2141×1603mm		2166×2370×1554mm		2440×2898×1554mm		
Main unit mass	2050kg		2950kg		3600kg		4500kg		

*1 The specific combination of 1X, 2X and 4X or 1X, 2X, 4X and 6X is available by custom order.

*2 The color LED lighting or halogen lighting specification is available by custom order.

*3 Determined by Mitutoyo's inspection method. L is the measured length (mm).

The optical condition for accuracy assurance is to be (QV-HR2.5X or QV-SL2.5X) + Low magnification of the tube lens.

*4 An excessively biased or concentrated load is excluded.

* The Laser Auto Focus (LAF) specification is available by custom order.

Ultra-high accuracy CNC vision measuring system ULTRA QV 404



ULTRA QV 404PRO

ULTRA QV 404

- The ULTRA QV 404 is an ultra-precise CNC vision measuring machine that realises a measurement accuracy of E,X,Y: $(0.25 + L/1000)\mu\text{m}$.
- To improve the maneuverability of each axis, Mitutoyo has employed aerostatic bearings, which Mitutoyo developed in our highly accurate 3D measuring machines, as the guidance systems for the X-, Y-, and Z-axes.
- This model is standard-equipped with an automatic temperature compensation function that uses a temperature sensor on the main unit of the measuring machine and a temperature sensor

for the workpiece, thus guaranteeing the stated accuracy specification applies over the temperature range of 19 to 23°C for stable measurement results.

- The model equipped with the tracking focus function that allows continuous focusing in response to change in workpiece height is also available. This results in improved measurement throughput.
- The accuracy of this model is conforming to ISO10360-7:2011 (specifications on request).

Specifications

Model		ULTRA QV 404	
Optical system		PRO	
Tracking Auto Focus device		—	●
Order No.		363-518SY	363-519SY
Measuring range (X×Y×Z)		400×400×200mm	
Resolution of scale / Scale type		0.01 μm / linear encoder	
Observation unit *1		PPT1X-2X-6X	
Imaging device		B&W CCD	
Illumination unit	Co-axial light	Halogen	
	Transmitted light	Halogen	
	PRL	Halogen	
Accuracy *2	E _{1X} , E _{1Y}	$(0.25+L/1000)\mu\text{m}$	
	E _{1Z} (50mm stroke)*3	$(1+2L/1000)\mu\text{m}$	
	E _{1Z} (Full stroke)	$(1.5+2L/1000)\mu\text{m}$	
	E _{2XY}	$(0.5+2L/1000)\mu\text{m}$	
On-screen repeatability		3 σ =0.2 μm	
Auto focus repeatability		σ =0.4 μm	
Operating temperature range	Ambient temperature	19 ~ 23°C	
	Temperature variation	0.5°C/1H and 1°C/24H	
Stage glass size		493×551mm	
Maximum stage loading *4		40kg	
Main unit external dimensions		1172×1735×1910mm	
Main unit mass (including the sub-base)		2150kg	
Operating air pressure		0.4 MPa*5	
Required air flow rate		300L/min(ANR)*6	
Temperature compensation function		automatic	

*1 The specific combination of 1X, 2X and 4X or 1X, 2X, 4X and 6X is available by custom order.

*2 Determined by Mitutoyo's inspection method. L is the measured length (mm).

The optical condition for accuracy assurance is to be QV-5X + Middle magnification of the tube lens.

*3 Verified at shipment from factory.

*4 An excessively biased or concentrated load is excluded.

*5 Air supply pressure to be in range 0.5 - 0.9MPa.

*6 Indicates the flow rate under normal conditions.

* The Laser Auto Focus (LAF) specification is available by custom order.

CNC Vision measuring system equipped with a touch/trigger probe: QV TP



QV TP Apex 302PRO

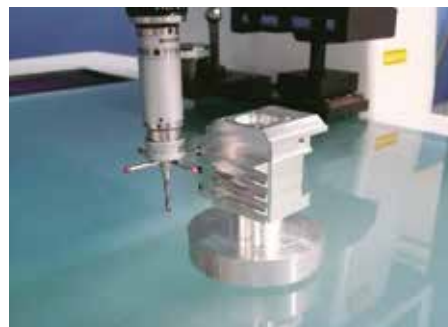

QV Touch-Trigger Probe

- The QV TP Series enables non-contact measurements and contact measurements on the same machine.
The QV TP Series has a vision measurement function and can also perform contact measurements by way of its touch-trigger probe.
- The QV TP Series can support measurements of 3D workpieces.
The QV TP Series can perform 3D measurements of workpieces, such as press-molded products, resin-molded products, and machined products, that could not be measured with conventional image processing alone.
- The QV TP Series is equipped with a probe module change rack.
Using the probe module change rack makes it possible to switch between vision measurement and touch trigger probe measurement during a sequence of automatic measurements.
Furthermore, storing the characteristics of different styli makes it possible to perform measurements on multiple surfaces.
- The accuracy of these models (excluding QV ACCEL type) is conforming ISO10360-7:2011 (specifications on request).

Specifications

QV TP ELF

Model		QV TP ELF
Optical system		PRO
Order No.		364-107SY
Measuring range by vision probe *1 (X×Y×Z)		250×200×200mm
Measuring range by touch probe *1 (X×Y×Z)		184×200×200mm
Resolution of scale / Scale type		0.1μm / linear encoder
Observation unit *2		PPT1X-2X-6X
Imaging device		B&W CCD
Illumination unit	Co-axial light	White LED
	Transmitted light	White LED
	PRL	White LED
Measuring accuracy *3 (Vision)	E _{1X} , E _{1Y}	(2+3L/1000)μm
	E _{1Z}	(3+5L/1000)μm
TP measuring accuracy *3	E _{1X} , E _{1Y} , E _{1Z}	(2.4+3L/1000)μm
Operating temperature range	Ambient temperature	18 ~ 23°C
	Temperature variation	0.5°C/1H and 1°C/24H
Stage glass size		312×269mm
Maximum stage loading *4		15kg
Main unit external dimensions		586×847×1528mm
Main unit mass (including the sub-base)		270kg
Temperature compensation function		manual

*1 Measuring range is smaller than the dimension in the specifications table above when the machine is equipped with module change rack, master ball and calibration ring.

*2 The specific combination of 1X, 2X and 4X or 1X, 2X, 4X and 6X is available by custom order.

*3 Determined by Mitutoyo's inspection method. L is the measured length (mm).

The optical condition for accuracy assurance is to be (QV-HR2.5X or QV-SL2.5X) + Middle magnification of the tube lens.

*4 An excessively biased or concentrated load is excluded.

* The Laser Auto Focus (LAF) specification is available by custom order.

Specifications

QV TP Apex

Model	QV TP Apex 302		QV TP Apex 404		QV TP Apex 606	
	PRO	PRO3	PRO	PRO3	PRO	PRO3
Optical system						
Standard machine	364-170SY	364-171Y	364-180SY	364-181Y	364-190SY	364-191Y
Tracking Auto Focus device	364-174SY	364-175Y	364-184SY	364-185Y	364-194SY	364-195Y
Measuring range by vision probe*1 (X×Y×Z)	300×200×200mm		400×400×250mm		600×650×250mm	
Measuring range by touch probe*1 (X×Y×Z)	234×200×200mm		334×400×250mm		534×650×250mm	
Resolution of scale / Scale type			0.1µm/linear encoder			
Observation unit*2			PPT1X-2X-6X			
Imaging Device	B&W CCD	3CCD Color	B&W CCD	3CCD Color	B&W CCD	3CCD Color
Illumination unit*3	Co-axial light		White LED			
	Transmitted light		White LED			
	PRL		White LED			
Measuring accuracy*4 (Vision)	E _{IX} , E _{IY}		(1.5+3L/1000)µm			
	E _{IZ}		(1.5+4L/1000)µm			
	E _{2XY}		(2+4L/1000)µm			
TP measuring accuracy*4	E _{IX} , E _{IY} , E _{IZ}		(1.8+3L/1000)µm			
Operating temperature range	Ambient temperature		18 ~ 23°C			
	Temperature variation		0.5°C/1H and 1°C/24H			
Stage glass size	399×271mm		493×551mm		697×758mm	
Maximum stage loading*5	20kg		40kg		50kg	
Main unit external dimensions	859×951×1609mm		1027×1407×1778mm		1309×1985×1794mm	
Main unit mass (including the sub-base)	360kg		579kg		1450kg	
Temperature compensation function			manual			

*1 Measuring range is smaller than the dimension in the specifications table above when the machine is equipped with module change rack, master ball and calibration ring.

*2 The specific combination of 1X, 2X and 4X or 1X, 2X, 4X and 6X is available by custom order.

*3 The color LED lighting or halogen lighting specification is available by custom order

*4 Determined by Mitutoyo's inspection method. L is the measured length (mm).

The optical condition for accuracy assurance is to be (QV HR2.5X or QV SL2.5X) + Middle magnification of the tube lens.

*5 An excessively biased or concentrated load is excluded.

* The Laser Auto Focus (LAF) specification is available by custom order.

Hyper QV TP

Model	Hyper QV TP 302		Hyper QV TP 404		Hyper QV TP 606	
			PRO			
Optical system						
Tracking Auto Focus device	—		●		—	
Order No.	364-173SY	364-177SY	364-183SY	364-187SY	364-193SY	364-197SY
Resolution of scale / Scale type			0.02µm/linear encoder			
Measuring accuracy*1 (Vision)	E _{IX} , E _{IY}		(0.8+2L/1000)µm			
	E _{IZ}		(1.5+2L/1000)µm			
	E _{2XY}		(1.4+3L/1000)µm			
TP measuring accuracy*1	E _{IX} , E _{IY} , E _{IZ}		(1.7+3L/1000)µm			
Operating temperature range	Ambient temperature		18 ~ 23°C			
	Temperature variation		0.5°C/1H and 1°C/24H			
Maximum stage loading*2	15kg		30kg		40kg	
Temperature compensation function			automatic			

*1 Determined by Mitutoyo's inspection method. L is the measured length (mm).

The optical condition for accuracy assurance is to be (QV HR2.5X or QV SL2.5X) + Middle magnification of the tube lens.

*2 An excessively biased or concentrated load is excluded.

Note: For other specifications, refer to QV TP Apex.

QV TP ACCEL

Model	QV TP ACCEL 808		QV TP ACCEL 1010		QV TP ACCEL 1212		QV TP ACCEL 1517	
	PRO	PRO3	PRO	PRO3	PRO	PRO3	PRO	PRO3
Order No.	364-315Y	364-316Y	364-335Y	364-336Y	364-355Y	364-356Y	364-375Y	364-376Y
Measuring range by vision probe*2 (X×Y×Z)	800×800×150mm		1000×1000×150mm		1250×1250×100mm		1500×1750×100mm	
Measuring range by touch probe*2 (X×Y×Z)	734×800×150mm		934×1000×150mm		1184×1250×100mm		1434×1750×100mm	
Measuring accuracy*1 (Vision)	E _{IX} , E _{IY}		(1.5+3L/1000)µm				(2.2+3L/1000)µm	
	E _{IZ}		(1.5+4L/1000)µm				(2.5+5L/1000)µm	
	E _{2XY}		(2.5+4L/1000)µm				(3.5+4L/1000)µm	
TP measuring accuracy*1	E _{IX} , E _{IY} , E _{IZ}		(1.8+3L/1000)µm		(3+4L/1000)µm		(6+7L/1000)µm	
Repeatability*1	Short dimension		XY		3σ=0.2µm			
	Long dimension		axis		3σ=0.7µm		3σ=1.5µm	
Operating temperature range	Ambient temperature		18 ~ 23°C					
	Temperature variation		0.5°C/1H and 1°C/24H					
Temperature compensation function			automatic					

*1 Determined by Mitutoyo's inspection method. L is the measured length (mm).

The optical condition for accuracy assurance is to be (QV-HR2.5X or QV-SL2.5X) + Low magnification of the tube lens.

*2 Measuring range is smaller than the dimension in the specifications table above when the machine is equipped with module change rack, master ball and calibration ring.

Note: For other specifications, refer to QV ACCEL.

NOTE: A start-up system (relocation detection sensor) is an integral security feature of machines of this series and will disable their operation if subject to relocation or strong vibration. Please be advised to contact your nearest Mitutoyo Service Centre as soon as possible or in advance of such circumstance.

Non-contact laser probe-equipped CNC vision measuring system QV HYBRID TYPE 1

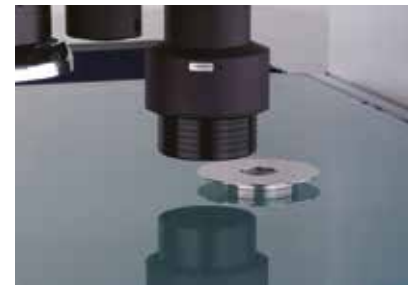

QV HYBRID TYPE 1

- The QV HYBRID TYPE 1 is a hybrid measuring machine that has a vision measurement function and can use the scanning function of its non-contact displacement sensor to measure very small steps and curved surfaces at high speeds.
- Mitutoyo's proprietary double-pinhole technique is used for the displacement sensor's detection method. Compared to the knife-edge and triangulation techniques, this method has the advantage of lower laser directivity.
- Because a focusing point method is used, the QV HYBRID TYPE 1 has the advantage that it is minimally affected by factors such as the color of the workpiece.
- The small laser spot diameter of approximately 2 μ m makes it possible to perform measurements with high horizontal resolution.
- The displacement sensor alone has a wide measuring range of ± 0.5 mm, which makes it possible to perform form measurements with a wide dynamic range. For displacements outside this range, scanning can be performed by moving the Z-axis.
- The accuracy of these models (excluding QV ACCEL and QV STREAM PLUS Type) is conforming to ISO10360-7:2011 (specifications on request).

Applications

Viewer function

The QV HYBRID Series provides the viewer function as standard. It allows you to easily set filter parameters and calculation items for laser scanning measurement while visual inspection is in progress.

A variety of laser scanning tools

A variety of scanning tools including line, cross, circle, and area are provided as standard for both Type 1 and 4.

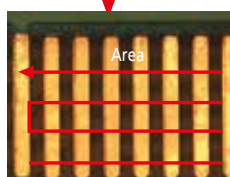

Workpiece: printed circuit board

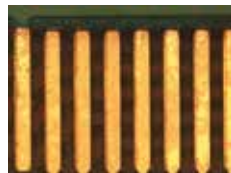

Prior confirmation with viewer



Profile assessment analysis with FORMPAK-QV

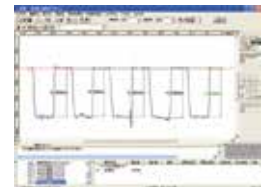

Form analysis with FORMTRACEPAK-PRO

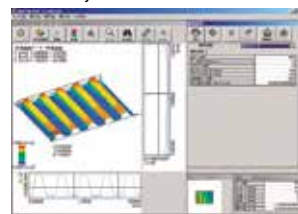

QV TraceMaker 7000

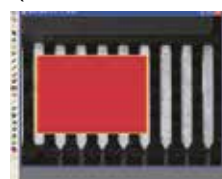

Trace route creation from image

This tool can create a trace route from a captured image. It is appropriate for measurement of complicated areas.

Specifications

QV HYBRID TYPE 1 Apex

Model	QVH1 Apex 302		QVH1 Apex 404		QVH1 Apex 606	
	PRO	PRO3	PRO	PRO3	PRO	PRO3
Order No.	365-170SY	365-171Y	365-180SY	365-181Y	365-190SY	365-191Y
Measuring range by vision probe (XxYxZ)	300x200x200mm		400x400x250mm		600x650x250mm	
Measuring range by displacement sensor (XxYxZ)	180x200x200mm		280x400x250mm		480x650x250mm	
Resolution of scale / Scale type	0.1µm / linear encoder					
Observation unit *1	PPT1X-2X-6X					
Imaging device	B&W CCD	3 CCD Color	B&W CCD	3 CCD Color	B&W CCD	3 CCD Color
Illumination unit *2	Co-axial light		White LED			
	Transmitted light		White LED			
	PRL		White LED			
Measuring accuracy *3 (Vision)	E_{1X}, E_{1Y}		(1.5+3L/1000)µm			
	E_{1Z}		(1.5+4L/1000)µm			
	E_{2XY}		(2+4L/1000)µm			
Displacement sensor measuring accuracy *3	E_{1Z}		(1.5+4L/1000)µm			
	Detecting range of probe itself		±0.5mm			
Displacement sensor	Vertical resolving power		10nm			
	Spot diameter		About ø2µm			
	Working distance (including the collision sensor)		5mm			
	Ambient temperature		20±1°C			
Operating temperature range	Temperature variation		2°C/8H			
	Stage glass size	399x271mm	493x551mm	697x758mm		
Maximum stage loading *4	20kg	40kg	50kg			
Main unit external dimensions	859x951x1609mm		1027x1407x1778mm		1309x1985x1794mm	
Main unit mass (including the sub-base)	370kg		589kg		1460kg	

*1 The specific combination of 1X, 2X and 4X or 1X, 2X, 4X and 6X is available by custom order.

*2 The color LED lighting or halogen lighting specification is available by custom order.

*3 Determined by Mitutoyo's inspection method. L is the measured length (mm). The optical condition for accuracy assurance is to be (QV-HR2.5X or QV-SL2.5X) + Middle magnification of the tube lens.

*4 An excessively biased or concentrated load is excluded.

Hyper QV HYBRID TYPE 1

Model	Hyper QVH1 302		Hyper QVH1 404		Hyper QVH1 606	
	PRO	PRO	PRO	PRO	PRO	PRO
Order No.	365-173SY		365-183SY		365-193SY	
Resolution of scale / Scale type	0.02µm / linear encoder					
Measuring accuracy *1 (Vision)	E_{1X}, E_{1Y}		(0.8+2L/1000)µm			
	E_{1Z}		(1.5+2L/1000)µm			
	E_{2XY}		(1.4+3L/1000)µm			
Displacement sensor measuring accuracy *1	E_{1Z}		(1.5+2L/1000)µm			
	Ambient temperature		18 ~ 23°C			
Operating temperature range	Temperature variation		0.5°C/1H and 1°C/24H			
	Temperature compensation function		automatic			
Maximum stage loading *2	15kg		30kg		40kg	

*1 Determined by Mitutoyo's inspection method. L is the measured length (mm). The optical condition for accuracy assurance is to be (QV-HR2.5X or QV-SL2.5X) + Middle magnification of the tube lens.

*2 An excessively biased or concentrated load is excluded. Other specifications are the same as those of the QVH1 Apex. For details, refer to above table.

QV STREAM PLUS HYBRID TYPE 1

Model	QVH1 STREAM 302		QVH1 STREAM 404		QVH1 STREAM 606	
	PRO	PRO	PRO	PRO	PRO	PRO
Order No.	365-172Y		365-182Y		365-192Y	
Imaging device	B&W CCD					
Illumination unit	Co-axial light		Color LED			
	Transmitted light		Blue LED			
	PRL		Color LED			
Measuring accuracy *1 (Vision)	E_{1X}, E_{1Y}		(1.5+3L/1000)µm			
	E_{1Z}		(1.5+4L/1000)µm			
	E_{2XY}		(2+4L/1000)µm			
Displacement sensor measuring accuracy *1	E_{1Z}		(1.5+4L/1000)µm			
	Ambient temperature		20±1°C			
Operating temperature range	Temperature variation		2°C/8H			

*1 Determined by Mitutoyo's inspection method. L is the measured length (mm). The optical condition for accuracy assurance is to be (QV-HR2.5X or QV-SL2.5X) + Middle magnification of the tube lens. Other specifications are the same as those of the QVH1 Apex. For details, refer to above table.

QV ACCEL HYBRID TYPE 1

Model	QVH1 ACCEL 808		QVH1 ACCEL 1010		QVH1 ACCEL 1212		QVH1 ACCEL 1517	
	PRO	PRO3	PRO	PRO3	PRO	PRO3	PRO	PRO3
Order No.	365-315Y	365-316Y	365-335Y	365-336Y	365-355Y	365-356Y	365-375Y	365-376Y
Measuring range by vision probe (XxYxZ)	800x800x150mm		1000x1000x150mm		1250x1250x100mm		1500x1750x100mm	
Measuring range by displacement sensor (XxYxZ)	680x800x150mm		880x1000x150mm		1130x1250x100mm		1380x1750x100mm	
Measuring accuracy *1 (Vision)	E_{1X}, E_{1Y}		(1.5+3L/1000)µm		(2.2+3L/1000)µm			
	E_{1Z}		(1.5+4L/1000)µm		(2.5+5L/1000)µm			
	E_{2XY}		(2.5+4L/1000)µm		(3.5+4L/1000)µm			
Displacement sensor measuring accuracy *1	E_{1Z}		(2.5+4L/1000)µm		(3.5+5L/1000)µm			
	Detecting range of probe itself		±0.5mm					
Displacement sensor	Vertical resolving power		10nm					
	Spot diameter		about ø2µm					
	Working distance (including the collision sensor)		5mm					
	Ambient temperature		20±1°C					
Operating temperature range	Temperature variation		2°C/8H					

*1 Determined by Mitutoyo's inspection method. L is the measured length (mm). The optical condition for accuracy assurance is to be (QV-HR2.5X or QV-SL2.5X) + Low magnification of the tube lens. Other specifications are the same as those of the QV ACCEL. For details, refer to page 14.

NOTE: A start-up system (relocation detection sensor) is an integral security feature of machines of this series and will disable their operation if subject to relocation or strong vibration. Please be advised to contact your nearest Mitutoyo Service Centre as soon as possible or in advance of such circumstance.

CLASS 1 LASER PRODUCT

Safety Precautions for Laser Beam

These systems uses a low-power invisible laser beam (780 nm) which corresponds to Class 1 (invisible light) of JIS C 6802 "Safety Standard of Laser Radiation Products". The class 1 laser warning label as shown above is attached to the main unit.

CNC vision measuring system equipped with non-contact scanning sensor: QV HYBRID TYPE 4



Hyper QV HYBRID TYPE 4 606PRO



QV HYBRID TYPE 4

- QV HYBRID TYPE 4 is equipped with CPS (Chromatic Point Sensor) that employs confocal method. This method uses the axial chromatic aberration to detect Z-axis direction position.
- The QV HYBRID TYPE 4 is a hybrid measuring machine that has a vision measurement function and can use the scanning function of its non-contact displacement sensor to measure very small steps and curved surfaces at high speeds.
- The displacement sensor detection method employs the wavelength confocal method that uses the axial chromatic aberration of the white light source. The sensor itself has a wide measuring range and has a high inclined-surface-following performance for both mirrored and diffusive surfaces.
- This system uses LEDs as light sources. Thanks to auto-brightness control, the sensor makes it possible to perform measurements that are minimally affected by reflectivity variations on the workpiece.
- The heights of two surfaces within the measuring range can be detected simultaneously, which makes it possible to support measurements of the thickness of thin, transparent objects.
- The accuracy of this model is conforming to ISO10360-7:2011 (specifications on request).

Measurement principle

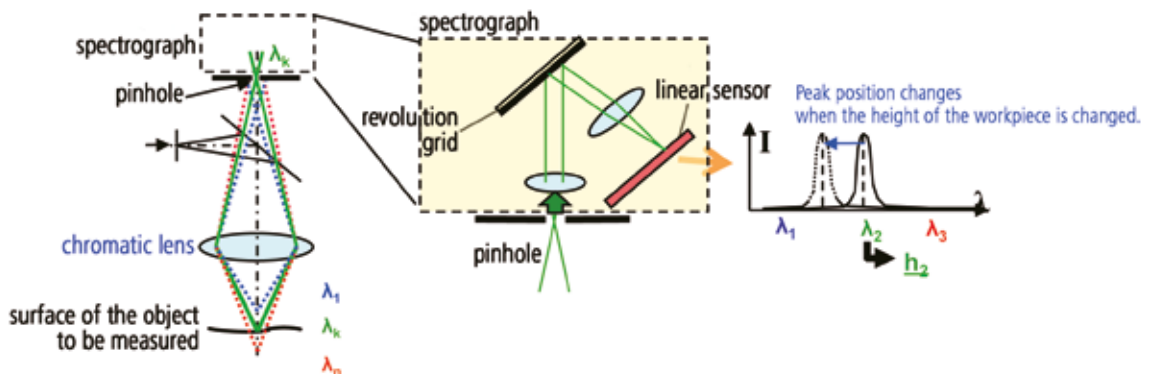

Scanning measurement with automatic movement of the Z-axis

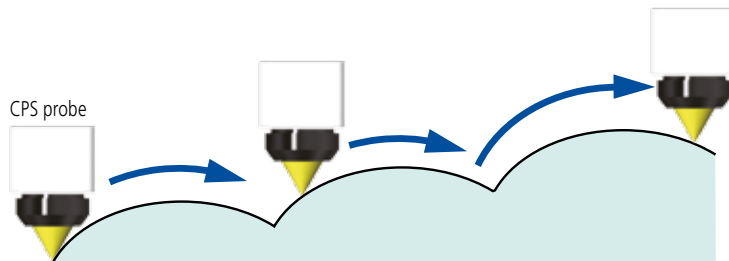

FORMTRACEPAK-PRO analysis example

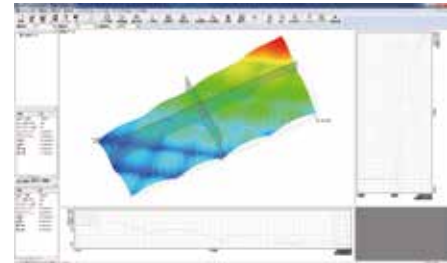

Color-coded 3D display

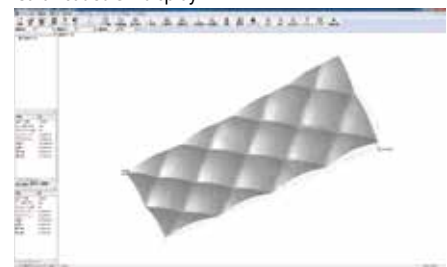

Shaded display

Specifications

QV HYBRID TYPE 4 Apex

Model	QVH4 Apex 302 PRO	QVH4 Apex 404 PRO	QVH4 Apex 606 PRO
Optical system			
Order No.	365-4135Y	365-4335Y	365-4535Y
Measuring range by vision probe (X×Y×Z)	300×200×200mm	400×400×250mm	600×650×250mm
Measuring range by displacement sensor (X×Y×Z)	176×200×200mm	276×400×250mm	476×650×250mm
Resolution of scale / Scale type	0.1μm / linear encoder		
Observation unit *1	PPT1X-2X-6X		
Imaging device	B&W CCD	B&W CCD	B&W CCD
Illumination unit *2	Co-axial light	White LED	
	Transmitted light	White LED	
	PRL	White LED	
Measuring accuracy *3 (Vision)	E _{1X} ,E _{1Y}	(1.5+3L/1000)μm	
	E _{1Z}	(1.5+4L/1000)μm	
	E _{2XY}	(2+4L/1000)μm	
Displacement sensor accuracy	E _{1Z}	(1.5+4L/1000)μm	
Displacement sensor	Detecting range of probe itself	±0.6mm	
	Vertical resolving power	25nm	
	Spot diameter	about ø4μm	
	Working distance (including the collision sensor)	21.0mm	
Operating temperature range	Ambient temperature	20±1°C	
	Temperature variation	2°C/8H	
Stage glass size	399×271mm	493×551mm	697×758mm
Maximum stage loading *4	20kg	40kg	50kg
Main unit external dimensions	859×951×1609mm	1027×1407×1778mm	1309×1985×1794mm
Main unit mass (including the sub-base)	370kg	589kg	1460kg

*1 The specific combination of 1X, 2X and 4X or 1X, 2X, 4X and 6X is available by custom order.

*2 The color LED lighting or halogen lighting specification is available by custom order.

*3 Determined by Mitutoyo's inspection method. L is the measured length (mm). The optical condition for accuracy assurance is to be (QV-HR2.5X or QV-SL2.5X) + Middle magnification of the tube lens.

*4 An excessively biased or concentrated load is excluded.

Hyper QV HYBRID TYPE 4

Model	Hyper QVH4 302 PRO	Hyper QVH4 404 PRO	Hyper QVH4 606 PRO
Optical system			
Order No.	365-4165Y	365-4365Y	365-4565Y
Resolution of scale / Scale type	0.02μm / linear encoder		
Measuring accuracy *1 (Vision)	E _{1X} ,E _{1Y}	(0.8+2L/1000)μm	
	E _{1Z}	(1.5+2L/1000)μm	
	E _{2XY}	(1.4+3L/1000)μm	
Displacement sensor accuracy	E _{1Z}	(1.5+2L/1000)μm	
Operating temperature range	Ambient temperature	18 ~ 23°C	
	Temperature variation	0.5°C/1H and 1°C/24H	
Temperature compensation function	automatic		
Maximum stage loading *2	15kg	30kg	40kg

*1 Determined by Mitutoyo's inspection method. L is the measured length (mm). The optical condition for accuracy assurance is to be (QV-HR2.5X or QV-SL2.5X) + Middle magnification of the tube lens.

*2 An excessively biased or concentrated load is excluded. Other specifications are the same as those of the QVH4 Apex. For details, refer to the table above.

NOTE: A start-up system (relocation detection sensor) is an integral security feature of machines of this series and will disable their operation if subject to relocation or strong vibration. Please be advised to contact your nearest Mitutoyo Service Centre as soon as possible or in advance of such circumstance.

Microscopic form measurement system UMAP Vision System TYPE 2



Stylus lineup

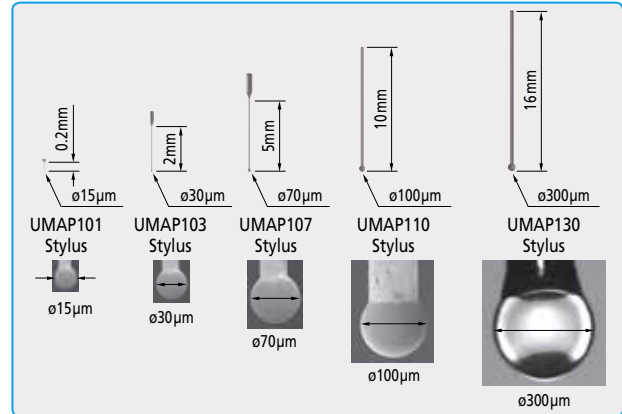

Measurement examples

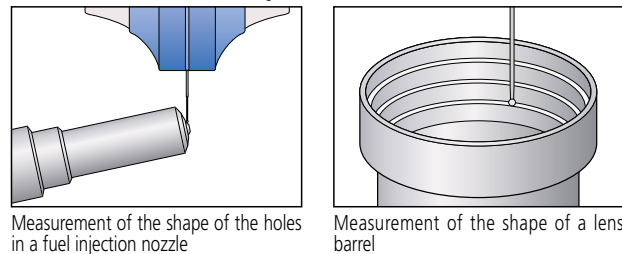

UMAP Vision System TYPE 2

- The UMAP Vision System uses Mitutoyo's proprietary sensing technology and is equipped with an ultra-low force probe. The utilisation of extremely small styli with high aspect ratios (styli with a diameter between 15µm and 300µm), makes dimension measurements of microscopic forms possible. These measurements cannot be made using conventional contact measurement sensors.

Specifications

Model	Hyper UMAP 302		ULTRA UMAP 404
Optical system	PRO		
Order No.	364-7135Y		364-7175Y
Measuring range (XxYxZ)	300x200x200mm		400x400x200mm Effective measuring range on glass surface: 360x400x200 mm*1
Effective measuring range (common between images and UMAP103)	185x200x175mm		285x400x175mm
Resolution of scale / Scale type	0.02µm/Linear Encoder		0.01µm/Linear Encoder
Observation unit*2	PPT1X-2X-6X		
Imaging device	B&W CCD		
Illumination unit	Co-axial light	White LED	Halogen
	Transmitted light	White LED	Halogen
Measuring accuracy*3	Vision	PRL	White LED
		E_{IX}, E_{IY}	(0.8+2L/1000)µm
		E_{IZ} (50mm stroke)*4	—
		E_{IZ} (full stroke)	(1.5+2L/1000)µm
	UMAP	E_{IX}, E_{IY} (UMAP 110)*5	(1.7+3L/1000)µm
UMAP repeatability*3	UMAP101, 103, 107	$\sigma=0.1\mu\text{m}$	$\sigma=0.08\mu\text{m}$
	UMAP110, 130	$\sigma=0.15\mu\text{m}$	$\sigma=0.12\mu\text{m}$
Operating temperature range	Ambient temperature	18 ~ 23°C	19 ~ 23°C
	Temperature variation		0.5°C/1H and 1°C/24H
Maximum stage loading*6	15kg		40kg
Operating air pressure			0.4MPa
Required air flow rate	—		300L/min (ANR)
Temperature compensation function			automatic

*1 Effective measuring range when contour light is used.
 *2 The specific combination of 1X, 2X and 4X or 1X, 2X, 4X and 6X is available by custom order.
 *3 Determined by Mitutoyo's inspection method. L is measured length (mm).
 *4 Verified at shipment from factory.
 *5 The assured accuracy of UMAP is specific to that of UMAP110 in the case of a measuring speed of 10µm/s.
 *6 An excessively biased or concentrated load is excluded.
 * The Laser Auto Focus (LAF) specification is available by custom order.

Non-contact 3D measuring system Hyper QV WLI

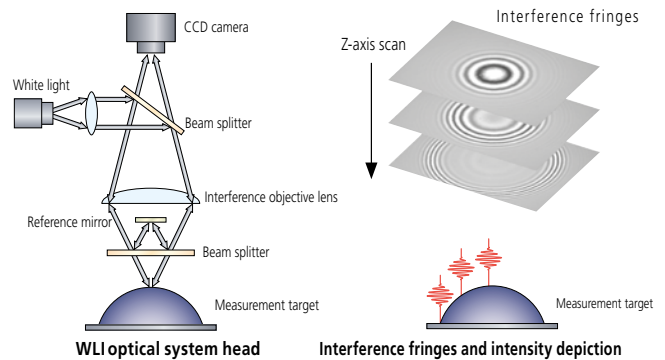

Hyper QV WLI

- The Hyper Quick Vision WLI is Mitutoyo's leading, highly accurate dual-head measurement system equipped with a white light interferometer (WLI) optical head.
- Equipping a vision measuring machine with a WLI head enables the machine to perform measurements ranging from 2D coordinate and dimension measurements to highly accurate 3D measurements on microscopic areas in applications such as surface analysis, small-diameter hole depth, and circuit board wiring dimensions.

Principle of WLI measurement

White light is split into two beams, one for the reference mirror within the interference objective lens and the other for the measurement sample. When the interference objective lens is swept in the Z-direction, white interference fringes are generated only for the area of the measurement sample that is in focus. The 3D shape of the object being measured is calculated by detecting the peak position of the interference fringe intensity at each pixel position of the CCD camera.

Specifications

Model	Hyper QV WLI 302	Hyper QV WLI 404	Hyper QV WLI 606
Optical system		PRO	
Order No.	363-7135Y	363-7145Y	363-7155Y
WLI optical head unit			
Measuring range *1 (X×Y×Z)	215×200×190mm	315×400×240mm	515×650×220mm
Imaging device		B&W CCD	
Illumination unit	Co-axial Light	Halogen	
Z-axis scanning range *2		170μm	
Z-axis repeatability		2σ±0.08μm	
Vision optical head unit			
Measurement range (X×Y×Z)	300×200×190mm	400×400×240mm	600×650×220mm
Resolution of scale / Scale type		0.01μm / linear encoder	
Observation unit		PPT 1X-2X-6X	
Imaging device		B&W CCD	
Illumination unit	Co-axial light	White LED	
	Transmitted light	White LED	
	PRL	White LED	
Measuring accuracy *3	E _{1X} , E _{1Y}	(0.8+2L/1000)μm	
	E _{1Z}	(1.5+2L/1000)μm	
	E _{2XY}	(1.4+3L/1000)μm	
Operating temperature range	Ambient temperature	20±1°C	
	Temperature variation	0.5°C/1H	
Stage glass size	399×271mm	493×551mm	697×785mm
Maximum stage loading*4	15kg	25kg	35kg
Main unit external dimensions	859×950×1606mm	1027×1407×1781mm	1309×1985×1792mm
Main unit mass (including the sub-base)	490kg	1160kg	2275kg
Operating air pressure		0.4Mpa	
Temperature compensation function		automatic	

*1 Movable range of WLI optical head. Three dimensional shape measurement using WLI is allowed within one field of vision.

*2 In case of standard mode. Applicable to max. 200μm by modifying scan pitch.

*3 Determined by Mitutoyo's inspection method. L is measured length (mm).

The optical condition for accuracy assurance is to be (QV-HR2.5X or QV-SL2.5X) + middle magnification of the tube lens.

*4 An excessively biased or concentrated load is excluded.

* Hyper QV WLI is not compatible with the Easy Editor function of QVPAK.

Dimensions

QV302

Unit: mm

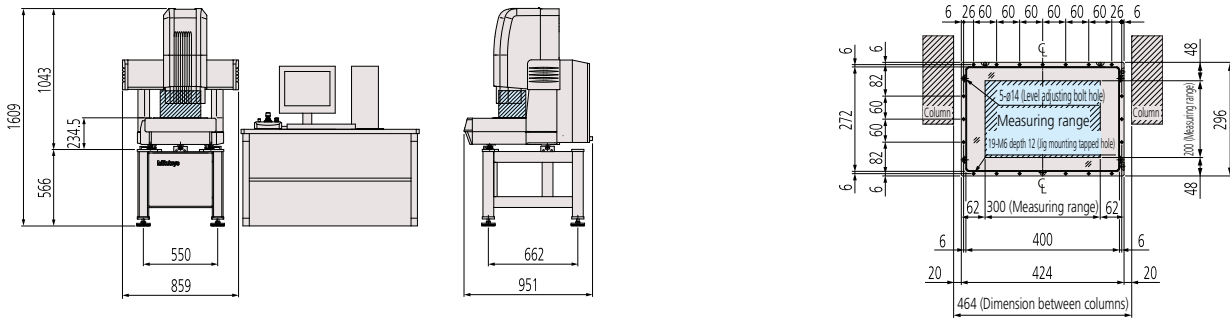

QV404

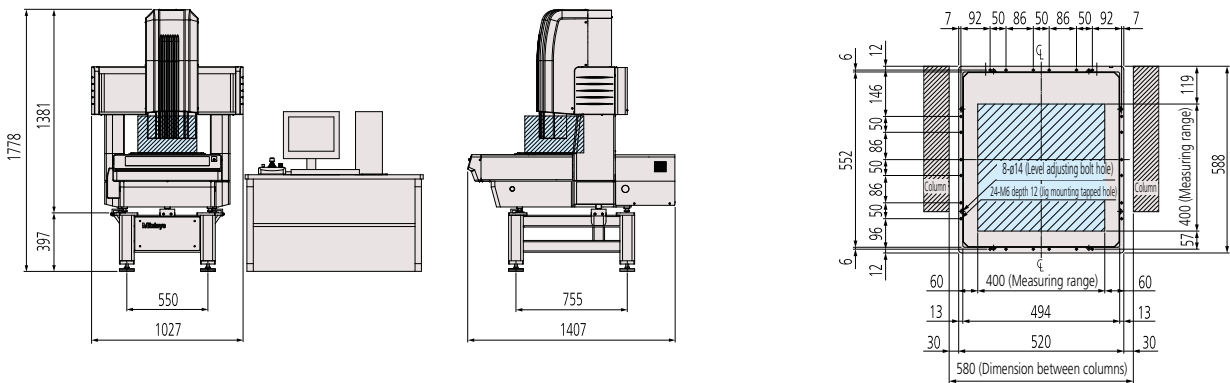

QV606

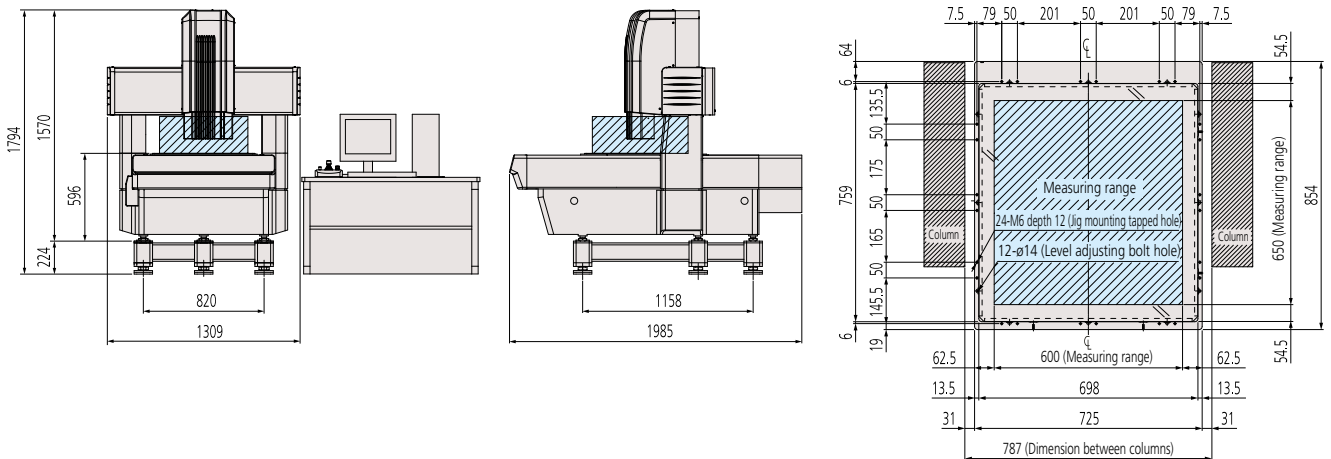

For more information about dimensions of the PC table, please contact your local Mitutoyo sales office.

Dimensions

ULTRA QV

Unit: mm

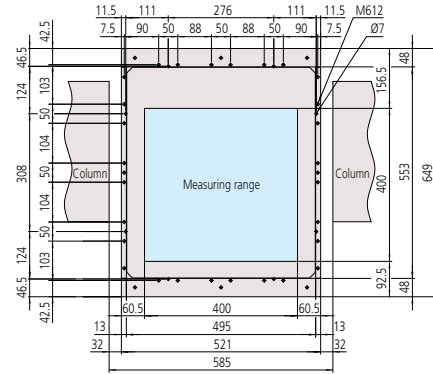
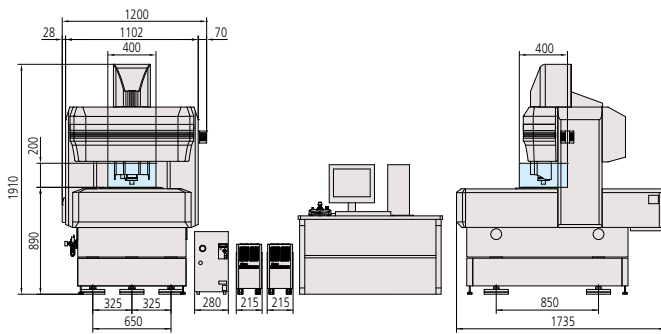

QV ELF

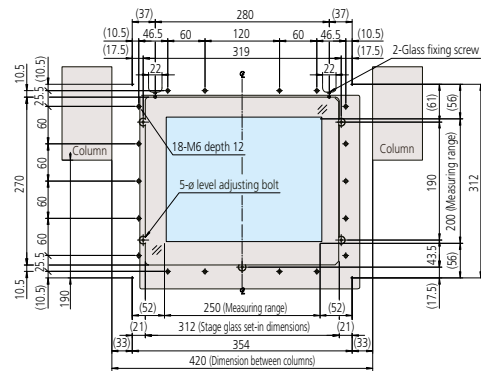
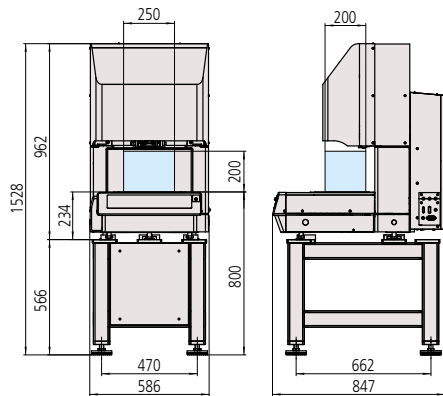

Dimensions in parentheses apply to LAF-equipped machines.

For more information about dimensions of the PC table, please contact your local Mitutoyo sales office.

Optional hardware / objective lenses

Calibration chart and QV compensation chart

Calibration chart

A calibration chart is used to compensate for the pixel size of the CCD chip and for the auto focus accuracy and optical axis offset at each magnification of the variable magnification unit (PPT).



* There are limitations on what functions can be used, depending on the lens. For details, contact your Mitutoyo sales office.

QV compensation chart*

This glass chart is used to perform compensation for distortions within the screen caused by the optical system, and auto focus compensation, which reduces auto focus variations that are caused by differences between the workpiece pattern and texture.



* There are limitations on what functions can be used, depending on the lens. For details, contact your Mitutoyo sales office.

QV index

Consecutive measurements of the sides and bottom of a workpiece can be made without having to perform re-fixturing. This leads to a decrease in the production costs re-related to fixturing, thus making for an improvement in measurement efficiency.

Supported models: QV302, 404, 606

Supported QVPAK versions: 7.356 and later

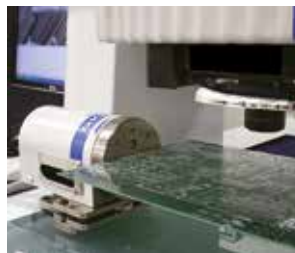

Item	Specifications
Maximum workpiece size	ø140 mm (Max)
Maximum faceplate loading	2 kg (Max)
Resolution	0.1°
Rotational positioning accuracy	±0.5°
Rotational speed	10 r.p.m.
External dimensions (WxDxH)	118x150x105 mm

QV objective lenses

QV objective lenses

Objective lens	QV-SL0.5x*	QV-HR1x	QV-SL1x	QV-HR2.5x	QV-SL2.5x	QV-5x	QV-HR10x*	QV-10x*	QV-25x*
Order no.	02AKT199	02AKT250	02ALA150	02AKT300	02ALA170	02ALA420	02AKT650	02ALG010	02ALG020
Optical magnification	0.5X	1X		2.5X		5X	10X		25X
Working distance	30.5 mm	40.6 mm	52.5 mm	40.6 mm	60 mm	33.5 mm	20 mm	30.5 mm	13 mm
PRO model imaging FOV [(H) mm x (V) mm]	Turret 1x	12.54x9.4	6.27x4.7		2.49x1.86		1.24x0.93		0.25x0.18
	Turret 2x	6.27x4.7	3.13x2.35		1.24x0.93		0.62x0.47		0.10x0.07
PRO3 model imaging FOV [(H) mm x (V) mm]	Turret 6x	2.09x1.56	1.04x0.78		0.41x0.31		0.20x0.15		0.04x0.03
	Turret 1x	9.4x7.04	4.7x3.52		1.87x1.41		0.93x0.7		0.18x0.14
PRO3 model imaging FOV [(H) mm x (V) mm]	Turret 2x	4.7x3.52	2.35x1.76		0.09x0.7		0.47x0.35		0.09x0.07
	Turret 6x	1.56x1.17	0.78x0.59		0.31x0.24		0.16x0.12		0.03x0.02

* When the QV-SL 0.5X, QV-HR 10X, QV-10X, or QV-25X objective lens is used, some limitations may occur, e.g. the insufficient illumination depending on the workpiece.



High-performance QV objective lenses

Software

Secure edge detection by advanced image processing

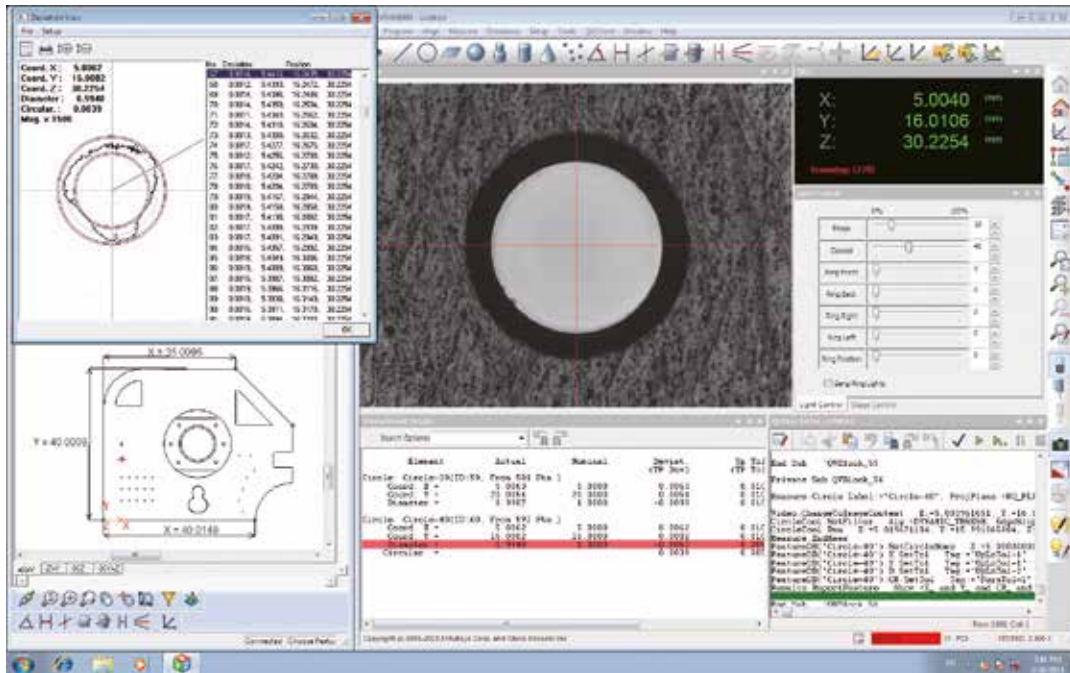

Edge detection tools



Point Tool

This is a basic tool for detecting one point.



Line Tool

This tool detects linear edges with a minimum of one pixel space. Compared to the point tool, the line tool can perform averaging and remove abnormal points, which enables stable measurements.

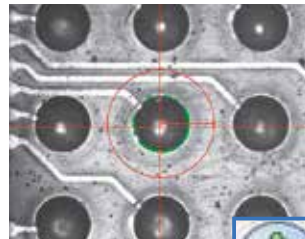

Circle Tool

This tool detects circular edges with a minimum of one pixel space. Edges can be specified easily with a single click.

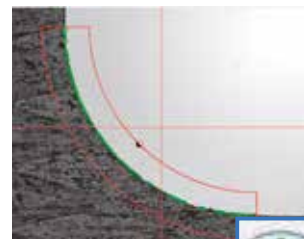

Arc Tool

This tool is suited to detection of arcs and corner radii.

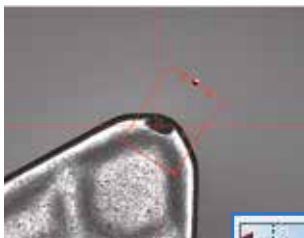

Maximum/Minimum Tool

This tool detects the maximum or minimum point within the range.



Area Centroid Tool

This tool detects the position of a form's centroid, and is suited to the positioning of different forms.

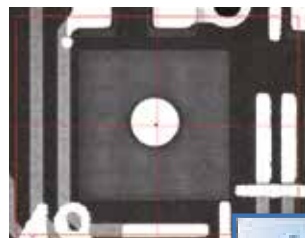

Pattern Search Tool

This tool performs pattern matching to detect a position, and is optimal for positioning alignment marks and similar tasks.

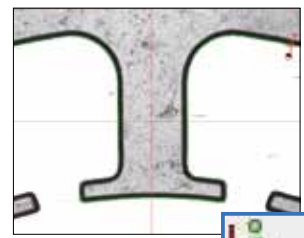

Auto Trace Tool

This is a shape-measuring tool that automatically tracks a contour with input consisting only of a start point and end point.



Equipped with powerful autofocus functions as standard

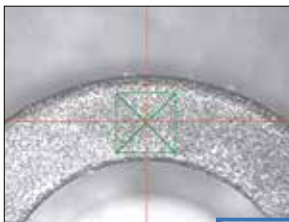

Surface Focus Tool

Image autofocus can be performed on a chosen area specified with the mouse. Highly accurate height measurements that are minimally affected by surface roughness can be performed even on objects such as resin-molded products and machined surfaces.

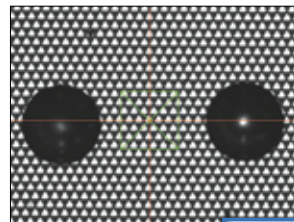

Pattern Focus Tool

Even low-contrast mirrored surfaces and transparent objects can be brought into focus by the use of pattern focus, which projects onto the workpiece surface a pattern placed within the light path. This is useful when performing height measurements of flexible printed circuit boards and film.



Edge Focus Tool

This is the optimal tool for focusing chamfered parts.

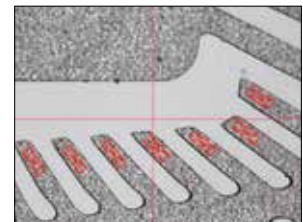

Multi-point autofocus

Multi-point autofocus can be used to set multiple focus positions, sizes and angles to chosen values. This tool can be used to obtain multiple sets of height information with a single focusing operation, which makes it possible to perform highly efficient height and flatness measurements.

One-click measuring tool setup

The tool size, orientation and threshold of a measuring tool are automatically set with one click of the mouse in the vicinity of the measurement location.

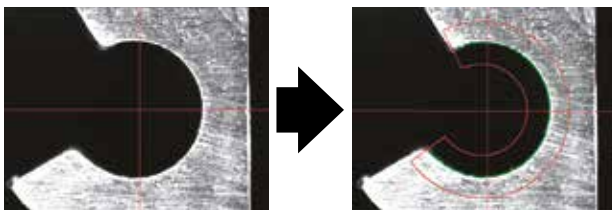

AI Illumination Tools

There are two tools: the dual area contrast tool, which can adjust the light intensity to the optimal value, and the brightness tool, which automatically compensates the light intensity – both at program creation time. These tools stabilise the light intensity during repeat measurements, which increases edge detection repeatability and reduces the occurrence of edge detection errors caused by light intensity fluctuations.

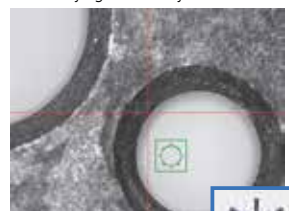

Brightness Tool



Dual Area Contrast Tool



Increase in edge detection capability

Workpieces that have been machined often have optically 'noisy' surfaces produced by cutter marks and marks caused by abrasive blasting of outer surfaces. There are times when conventional image processing alone is not enough to perform accurate measurements when such noise is present. QVPAK's filter function removes this noise to make highly accurate measurements possible.

Preview screen of morphological filter

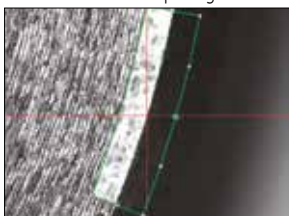

Edge detection using morphological filter

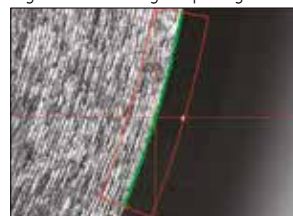

Brightness analysis

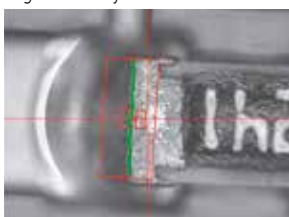

Texture analysis

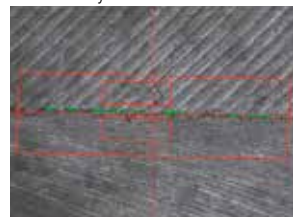

Illumination Wizard

This tool automatically sets the optimal illumination conditions from among multiple combinations of illumination types such as contour illumination and surface illumination and the illumination direction and angle of PRL illumination.

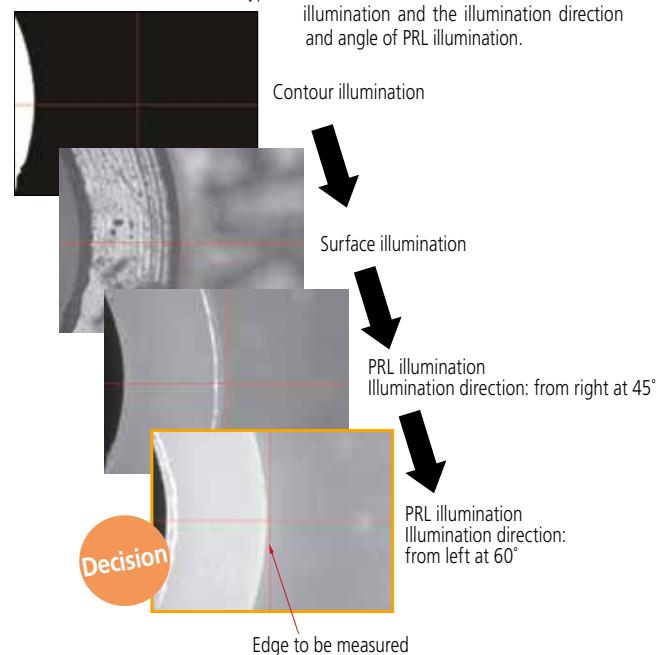

Software

Equipped with the EasyEditor, QVPAK has evolved to the most user-friendly and powerful version ever

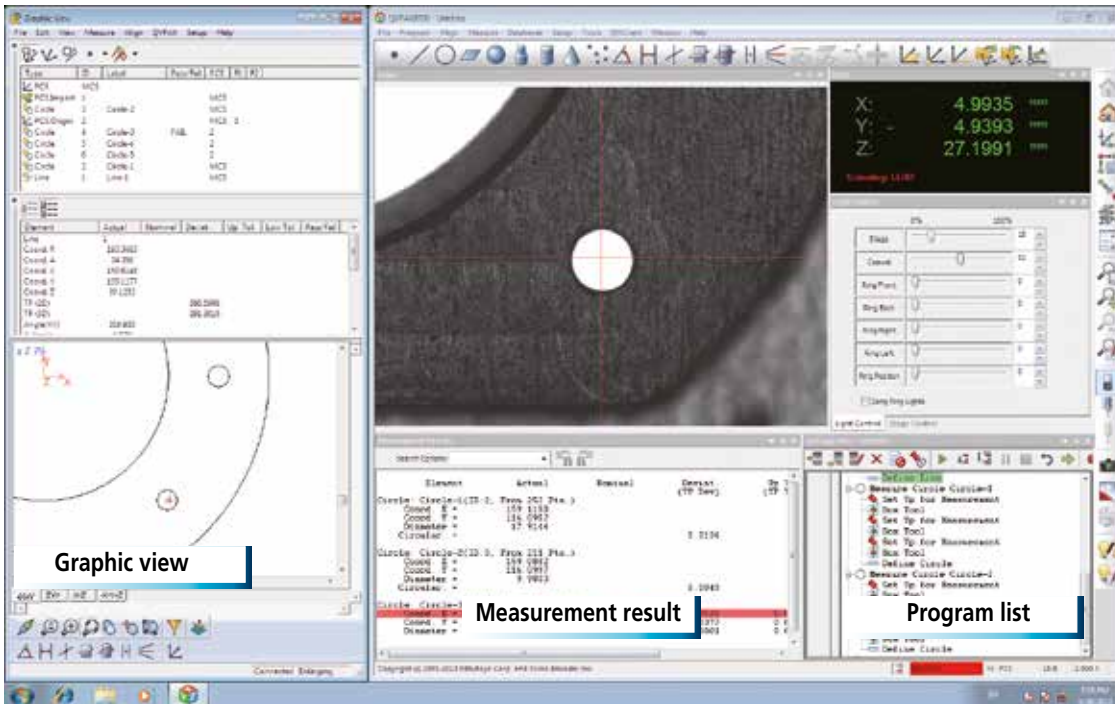

Graphic view

Measurement result

Program list

Highly powerful software: sophisticated, intelligent and easy to use

QVPAK has evolved to the most powerful version yet with both QV EasyEditor, which is easy to operate and requires no specialised knowledge, and QV BasicEditor, which boasts all the functions necessary to satisfy software developers.

Program creation example: measuring the distance between two circles

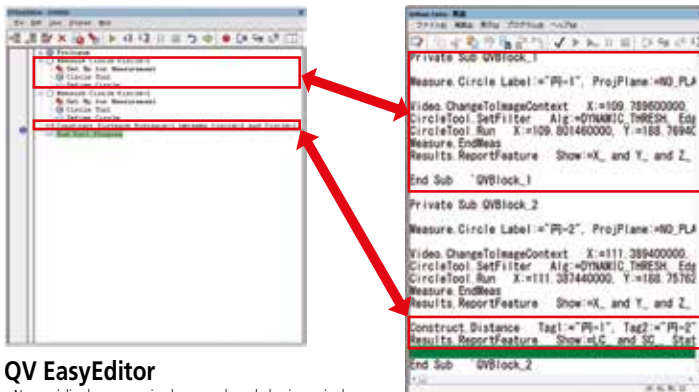

QV EasyEditor

- No specialised programming language knowledge is required.
- The procedure adjustments associated with changes to the work-piece form can be done easily.
- Edge detection tool corrections can be made from the video window.
- Mistakes during program creation can be fixed on the spot.
- Errors during repeat execution can also be fixed on the spot easily.

QV BasicEditor

- Both subroutines, which have arguments and return values, and local variables can be used, which makes QV Basic Editor suited to high-level programming.
- All flow control statements, such as IF, THEN, and ELSE, can be used.
- Data can be read from and written to text files.
- User-designed dialog boxes can be created.

Quick problem-tackling with error icons and auto-scroll function

Error icons are displayed in the program list, which makes it possible to quickly identify the areas that need to be fixed.

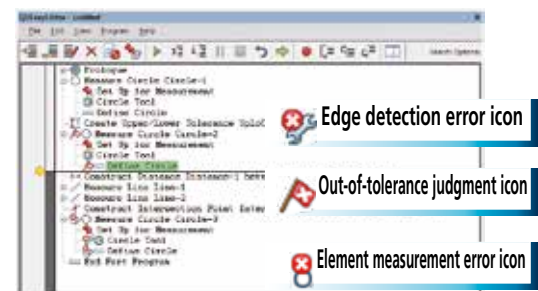

The program list, measurement result, and graphic view are linked through the auto-scroll function. This is useful in identifying the areas that need to be fixed in the program.

On the measurement result window, out-of-tolerance measurement results are highlighted in red. This clearly identifies problems.

Easy program correction when errors occur during recording mode and during part program execution

It's easy to insert, delete, and change procedures even during recording mode.

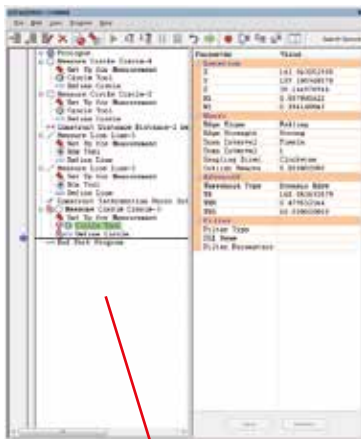

Editing tools

If an edge detection error or auto-focus error occurs during part program execution, error recovery mode can be used to update the program.

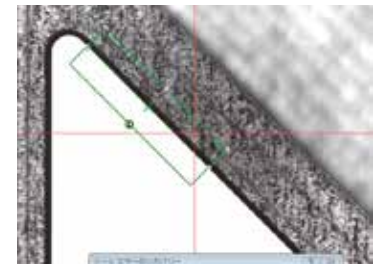
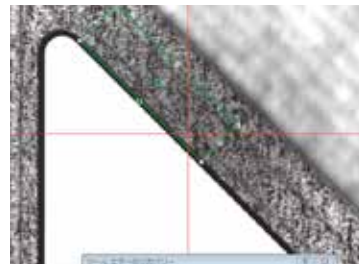

An error occurs during program execution due to an issue such as a mistake during program creation or a workpiece design change.

The details corrected in error recovery mode are updated.



Partial execution of measurement programs

It is even possible to reduce the measurement time of part programs that have a large number of elements by partially executing the program.

This function is effective in identifying the cause of failures, as it makes it possible to execute only the parts of a program that are failing, such as the parts in which out-of-tolerance values are present.

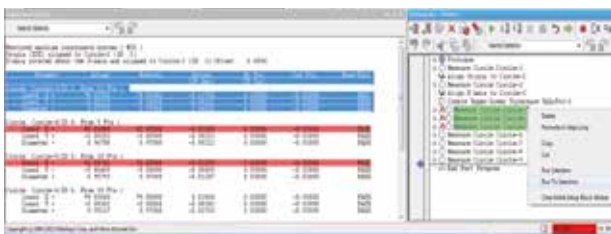

Repeated execution (Step and Repeat) can easily be programmed

The repeat command can effortlessly be set on the graphic display. Furthermore, even if parts of the workpiece are missing, steps can be deleted easily.

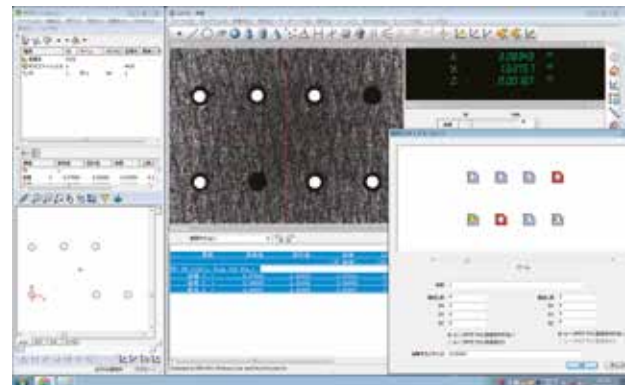

Calculation function examples

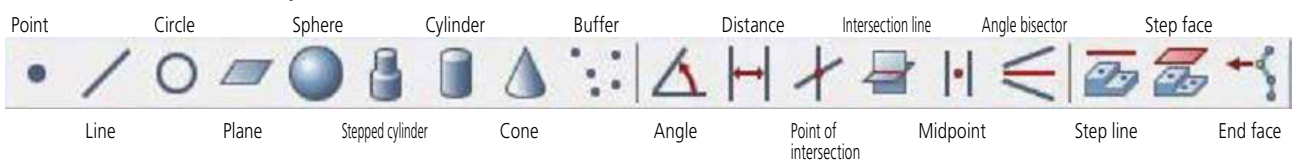

Software

Powerful software solutions simplify operability

QVGraphics

Not only can this feature be used for reports of measurement results, it can also perform calculations between elements and PCD measurements by selecting diagrams with the mouse. In addition, effective use of the graphics function makes it possible to easily edit part programs and is also useful in checking the coordinate system of the current workpiece and in checking for any forgotten measurements.

Furthermore, QVGraphics has a function for drawing geometric deviations of lines, circles, planes, cylinders, and spheres.

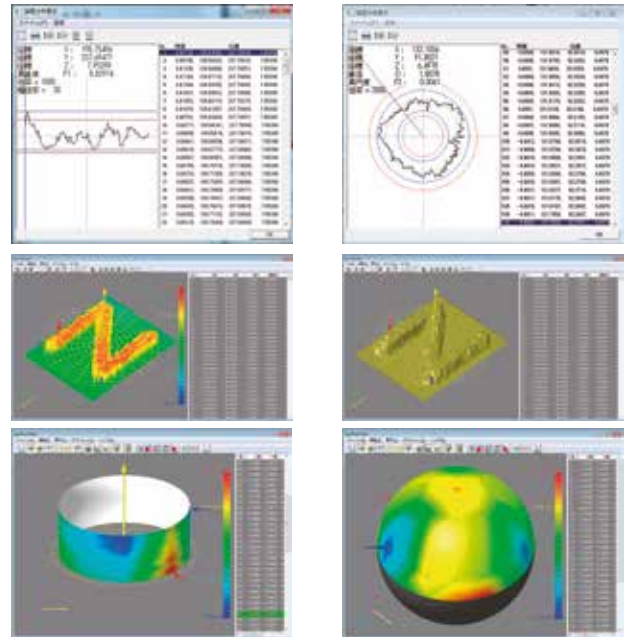
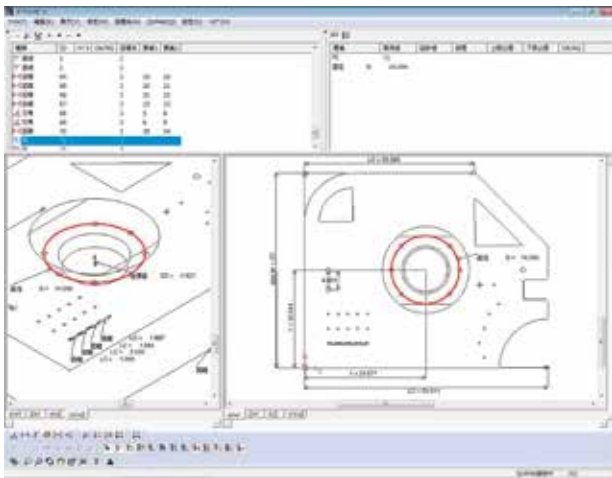

Image Composition

This function combines multiple images of surfaces at different heights to create a complete focal point image in focus over a wide range.



Original data

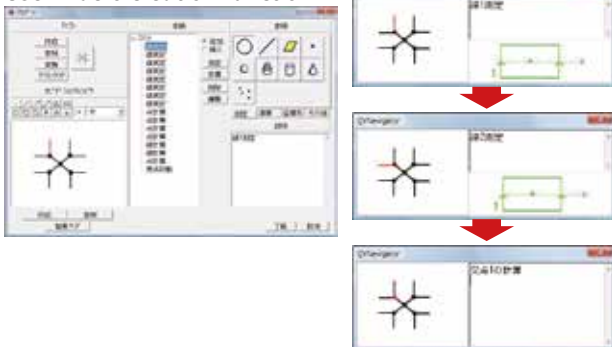

Image data after composition

QVNavigator

This function provides a guided navigation for the procedures for calculations between elements and for coordinate system setup patterns. The user macro creation function can be used to freely customise even complex patterns. Also, part programs can be registered together with workpiece images, which improves the operability of repeat measurements.

User macro creation function



Part program registration example



QVTracePlanner

QV Trace Planner is an application software that uses edge detection to measure contour forms. This software can easily generate trace routes even for forms that have varying heights and for forms that require multiple illumination conditions. Furthermore, after measurements are complete, FORMPAK-QV (optional) can start and perform analysis automatically, which achieves seamless operability.



measurements are complete, FORMPAK-QV (optional) can start and perform analysis automatically, which achieves seamless operability.

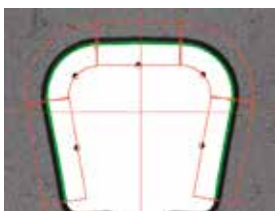

Trace route image generated by QV Trace Planner
(The actual operations are performed by executing one tool at a time.)



Actual example of FORMPAK-QV analysis

Function for removal of abnormal points at the element level

In addition to removing abnormal points per tool, they can also be removed from specific elements. Even when measurements are being performed on multiple screens, the abnormal point removal settings can easily be configured while viewing the graphic screen.

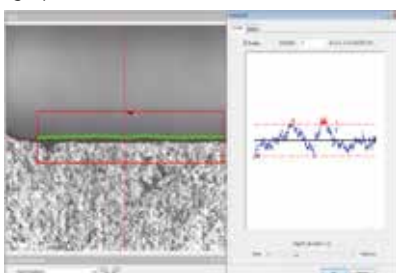

Multi-point autofocus

The autofocus tool has been subdivided. Chosen sizes, positions and angles can be set for multiple auto-focus tools. Multiple data points can be obtained with a single focus operation. It is possible to not only perform efficient height measurements but also to determine the maximum point, minimum point and average point from the acquired data.

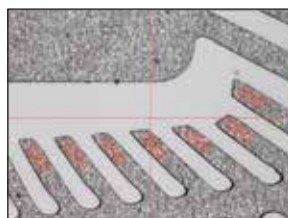
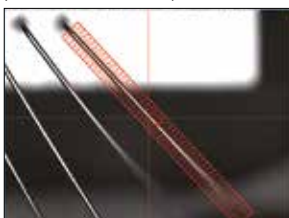

Help function

The Help function has been enhanced by help of a great number of graphics. Operators can conduct searches by topics and quickly find matching solutions to their queries.



Best fit function

The best fit function considers items such as the skew and elasticity of the workpiece, and then sets the coordinate system accordingly. Multiple elements determine origin and reference axes. Hence, measurements can be performed with a coordinate system that is more optimised than with conventional coordinate system settings.

Conventional coordinate system setting
Point that is not considered when setting the coordinate system

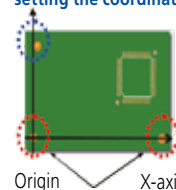

Origin X-axis
The origin and the axis are determined to be separate elements.

Coordinate system setting using best fit

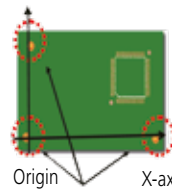

Origin X-axis
The coordinate system is set so that the alignment mark position offset errors are minimised.

Smart Recovery Function

When edge detection or autofocus errors, which are caused by variations in the workpieces or setting errors, occur, the smart recovery function automatically corrects illumination conditions and tool position, and then performs the measurement again.



The workpiece is not located at the conventional measurement position.

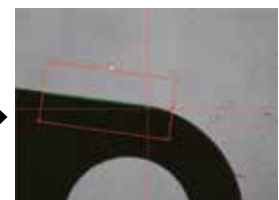

The tool is automatically corrected, and the measurement is then performed again.

Optional software

Form evaluation and analysis software

FORMPAK-QV

FORMPAK-QV performs tolerancing and form analysis from data obtained with the QV's auto-trace tool, non-contact displacement sensor, QV-WLI, and PFF.

Contour Tolerancing function

- Design data creation
CAD data conversion, master workpiece conversion, function specification, text file conversion and aspherical surface design value creation
- Tolerancing
Normal vector direction tolerancing, axial direction tolerancing and best-fit tolerancing
- Result display
Result list display, error graph, error developed view, error coordinate display function and analysis result display

Report Creation function

- Measurement result, error graph, and error developed view

Other functions

- Recording and executing analysis procedures
- External output function:
CSV format, ASCII and text
- Fairing processing
- Quadratic curve fitting function
- Pseudo-roughness analysis function

Microscopic Form Analysis

- Analysed items: point measurement, line measurement, circle measurement, distance measurement, intersection measurement, angle measurement, origin setting, and axial rotation
- Calculated items: maximum, minimum, average, standard deviation and area

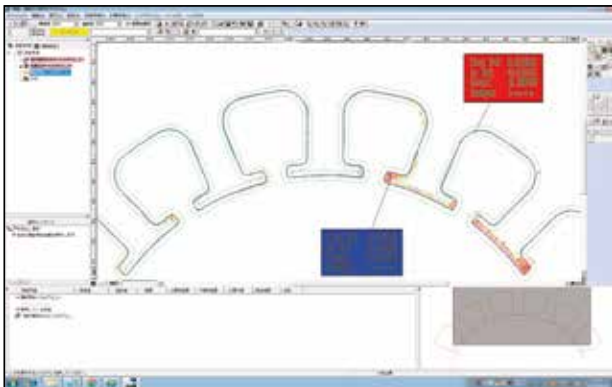

Tolerancing example

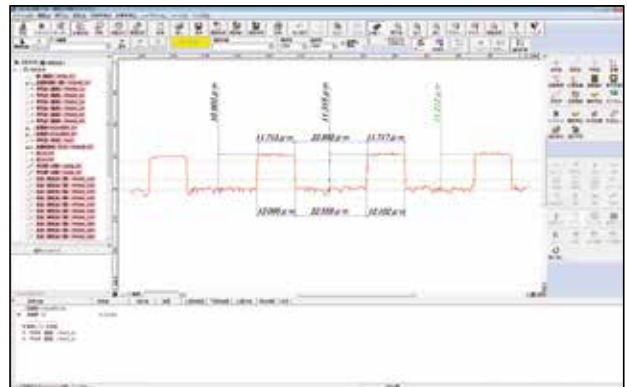

Example of using QV-WLI to perform line and space and conductor thickness measurements on a printed circuit board

QVTraceMaker

QV Trace Maker is a software application that creates scanning routes for the non-contact displacement sensor based on the images acquired by Quick Vision. Using this software together with FORMTRACEPAK-PRO and MSHAPE-QV makes it possible to perform highly accurate 3D form measurements.

Automatic image composition outside the field of view can be performed when acquiring images, which not only makes it possible to create wide-area trace routes but also enables the easy creation of trace routes of complicated and unusual form areas.

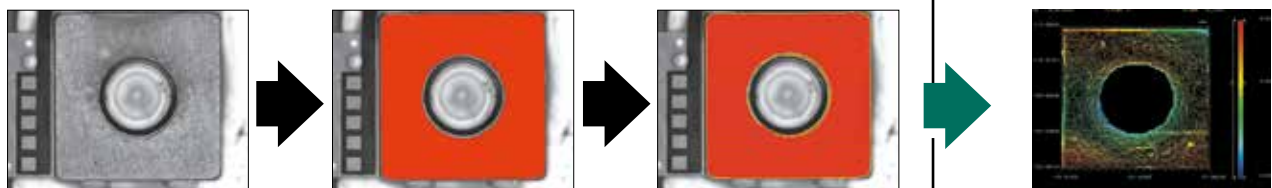

Target area image composition

Measuring area specification

Trace condition setup

MSHAPE-QV evaluation example

FORMTRACEPAK-PRO

FORMTRACEPAK-PRO is a software application that performs 3D analysis processing on the data obtained with the non-contact displacement sensor, QV-WLI and PFF.

Main functions

- **3D display**

Wire frame, shading, contour line, contour line filling

- **Trend compensation and filter processing**

Trend compensation using flat surfaces, spherical surfaces, cylindrical surfaces, and polyhedrons
1D and 2D digital filters for each profile

- **Digitisation of a rich variety of surface textures**

Relative load curves and area distribution curves can be used to evaluate wear and oil accumulation areas.
Spectral analysis, cutoff area and volume analysis, angle of inclination calculations at peaks and valleys and histogram calculations of numbers of valleys can be performed.

- **Function for extracting features from measurement data**

Extraction of a chosen cross section, slope enhancement and simultaneous analysis of the peaks and valleys of the cutoff surface can be performed.

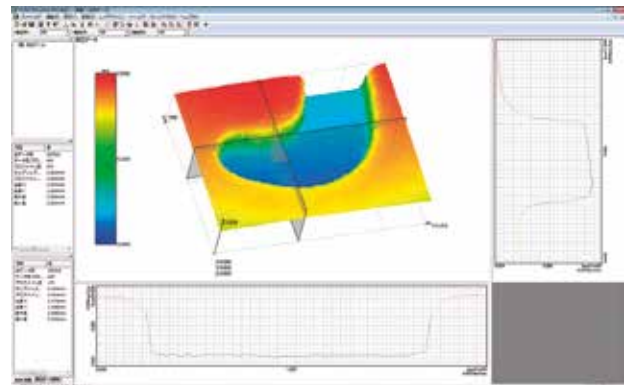

Example of using PFF to measure a molded component



Shading display

Cutoff surface analysis example

Wire frame display

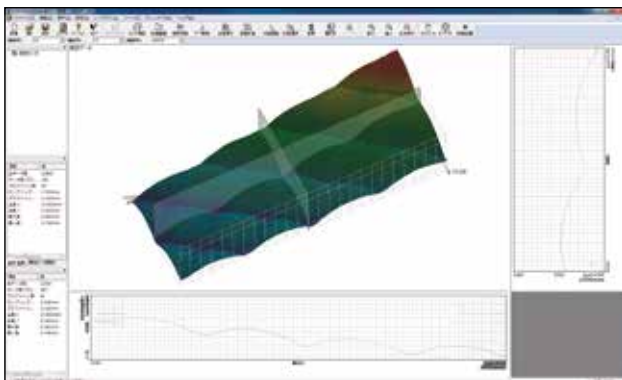

Example of using QVH4 to perform acrylic lens eye measurements

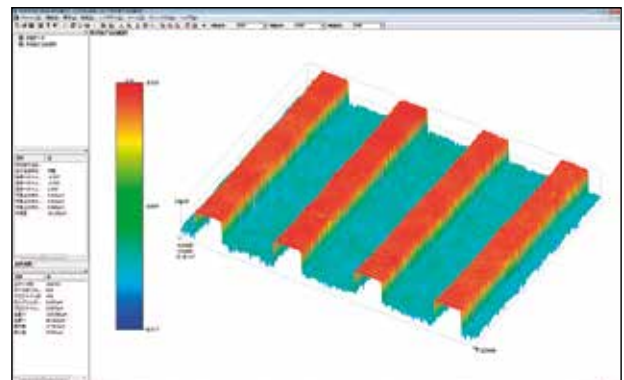

Example of using QV-WLI to perform line and space measurements on a circuit board

Optional software

Inspection certificate creation

MeasurLink STATMeasure PLUS

Many types of statistical calculations can be performed on the measurement results. It is also possible to display control charts in real time.

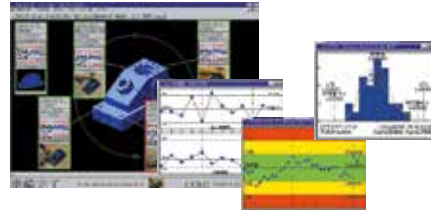

Offline teaching software

EASYPAG-PRO

DXF **IGES** **GERBER data**

EASYPAG-PRO can use 2D CAD data to create QVPAK part programs offline. This reduces the number of man-hours required to create part programs, which results in a decrease in lead time.

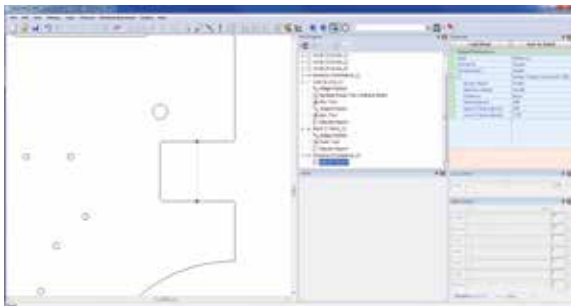

Line-to-arbitrary-point distance measurement

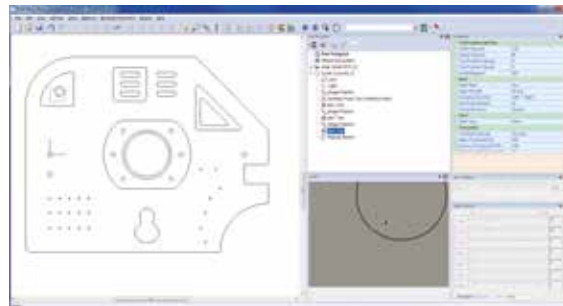

Offline teaching operation display

PAGPAK

DXF **IGES** **CSV** **NC data** **EXCELLON data** **GERBER data**



Measurement result: scatter chart display

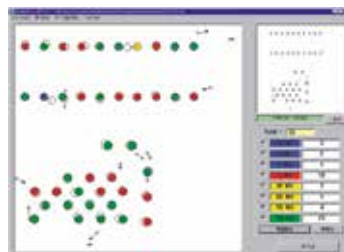

Measurement result: colour coding

Features

- Suitable for creating measurement procedure programs that measure discrete holes on printed circuit boards and similar workpieces
- Automatic optimisation of the movement route and batch measurements, in which multiple holes are included on a single screen, improve measurement throughput.
- A repeater function, which is useful in performing consecutive measurements of identical forms, is provided.
- A reporter function, which can make best fit corrections of measurement results, display approval/rejection judgments by colour, display error directions and display scatter charts.

Online teaching software

QV3DCAD-OnLine

QV3DCAD-OnLine uses 3D CAD models to easily create QVPAK part programs. QV measurements can be performed by specifying an element in the CAD data. This improves program creation efficiency more than using a joystick to perform teaching.

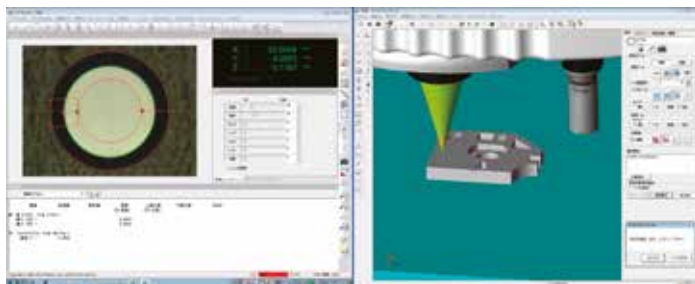

Primary display: QVPAK

Secondary display: QV3DCAD-OnLine

Supported CAD formats

Format	Supported version
SAT	Up to version 19
STEP*	AP203 and AP214 (graphics only)
VDAFS*	Up to version 2.0 of VDA-FS
IGES*	Up to version 5.3 of IGES
CATIA V4*	Version 4.1.9 to version 4.2.4 of CATIA V4
CATIA V5*	Release 2 to 17 of CATIA V5
Pro/E*	Version 16 of Pro/E to WildFire2 and WildFire3
Parasolid*	Version 10 to version 18 of Parasolid
Unigraphics*	V11 to V18 of Unigraphics and NX1 to NX7
SolidWorks*	SolidWorks 98 to 2006

* optional

Online teaching of illumination conditions and edge detection thresholds

QV3DCAD-OnLine can be used to teach correct illumination conditions and edge detection thresholds from actual images. The operation of the created program path can be checked immediately. This minimises the operation check and program editing work that needs to be performed after the program is completed.



Simulations and checks for interference provide accurate operation

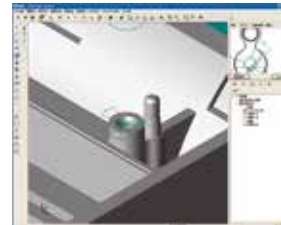

Edge detection tool simulations can be performed from the pseudo-video window.

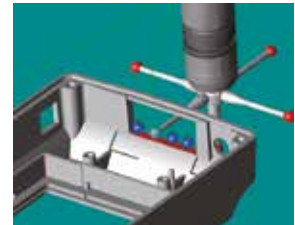

The interference check function avoids problems caused by the probe or objective lens colliding with the workpiece.

QV-CAD I/F

DXF **IGES**

QV-CAD I/F improves the measurement operability by displaying CAD data in the graphic window.

Features

- A navigation function that uses CAD data (the import function) and a function for generating measurement result data (the export function)
- Design value information can be referenced from CAD data, which eliminates the need for key entry of design values during nominal tolerancing.
- The 3D CAD import function can be used to display 3D CAD data and to configure flatness display area settings.

CAD Export Function



Drawing a graphic of the measurement result

Generated CAD data

3D CAD Import Function

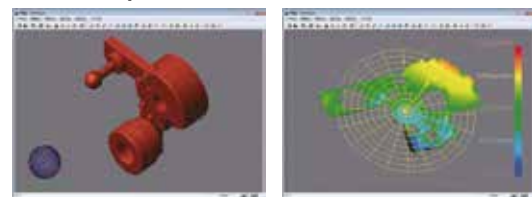

3D CAD data display

Illustrating flatness using 3D CAD data

Optional software

QV3DPAK

QV3DPAK is a software application that composes 3D forms from PFF (points from focus) or WLI (white light interferometer) data.

Main Functions

3D form data composition

- QV-WLI 3D form data composition
- PFF 3D form data composition
- Form data noise elimination
- Form data Gaussian filter processing

3D form data external output

- Transfer of extracted data to QVPAK
- Transfer of extracted data to FORMPAK-QV
- Transfer of extracted data to FORMTRACEPAK-PRO

3D profile stitching

If a measuring target area cannot be covered with a single FOV (field of view) measurement, this function allows stitching of 3D profile data in multiple FOVs. 3D profile stitching enables an extensive range of measurement and analysis as a high resolving power is maintained.

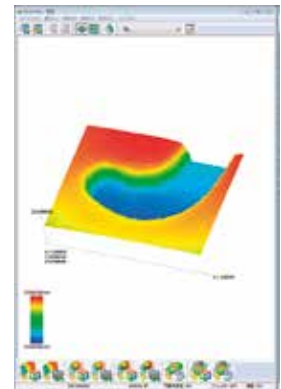
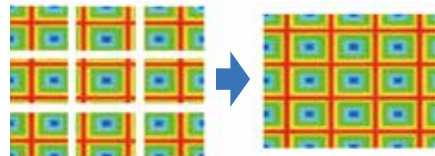

QV3DPAK

About the PFF (Points From Focus) function

PFF (points from focus) is an application that can use the image contrast of the Quick Vision Series to perform non-contact 3D form measurements. The Mitutoyo inspection method assures the Z-direction repetition accuracy, so it is possible to perform highly accurate form measurements.

PFF principle

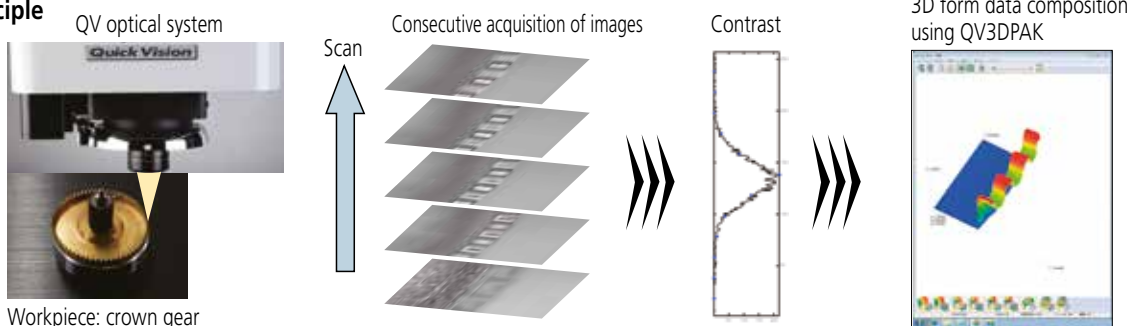

PFF measurement example

Partition line of a molded product

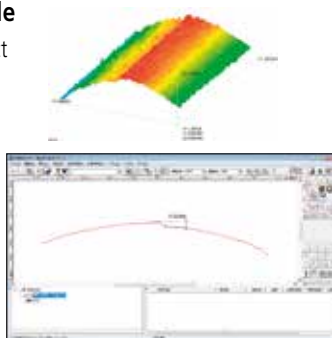

IC package BGA

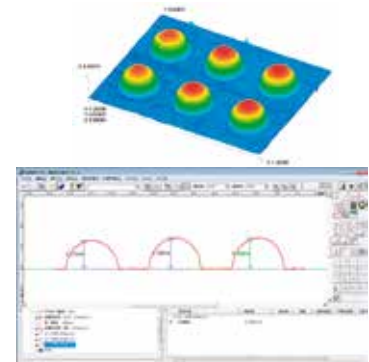
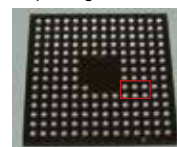

PFF measurement performance

PFF performance is assured when using the Mitutoyo inspection method, the Z-direction repetition accuracy.

	QV-ELF	QV-Apex	Hyper-QV	ULTRA-QV
Z-direction repetition accuracy	$2\sigma \leq 2.0 \mu\text{m}$	$2\sigma \leq 1.5 \mu\text{m}$	$2\sigma \leq 1.5 \mu\text{m}$	$2\sigma \leq 0.7 \mu\text{m}$
Optical magnification is assured to be accurate	QV-HR 2.5X + PT2X	QV-HR 2.5X + PT2X	QV-HR 2.5X + PT2X	QV-5X + PT2X

* When using the PFF function, employ the QV3DPAK software and a PFF-compatible objective (described on page 27).

* The PFF-compatible models are the PRO versions of the machines listed in the table above (including TP, HYBRID and UMAP machines).

QVPartManager

QVPartManager is the part program execution management software for multiple workpieces arranged on the measuring stage. It is possible to create mapped displays of execution conditions and approval/rejection judgment results for each measurement workpiece. A retry function and a pass function are available for use when tolerances are exceeded or when an error occurs. These functions are effective in simplifying operations during repeat execution.

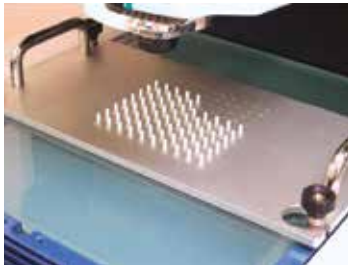

Workpieces arranged on a dedicated fixture



QVPartManager screen

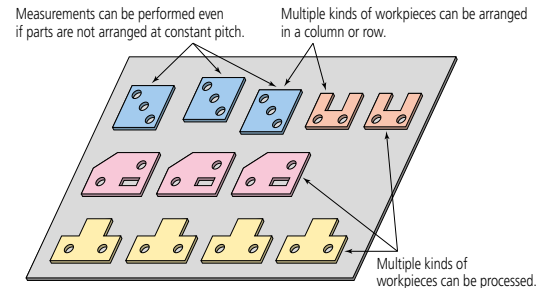

QVEio

QV Eio is a client application software for performing external control of the QV. To match different uses, three types of this software include: QVEio-PLC, QVEio-PC, and QVEio-Signal.

QVEio-PLC

QVEio-PLC is a software that can perform execution commands sent to the QV from an external source and provide status notifications in response to received commands by way of RS-232C communication with a PLC. Using this software makes it easy to construct a QV automated system such as by making a connection to an automatic conveyance robot.

Main Control Commands

PLC

- ABS start command
- Measurement start command
- Measurement stop command
- X-, Y-, Z-axis movement command

QVEio-PLC

- ABS complete
- Measurement complete
- Measurement stop complete
- Measurement result judgment (pass or fail)
- X-, Y-, Z-axis movement complete
- Reading or writing device information*

* This function uses QVBasic language commands.

QVEio-PLC supported example

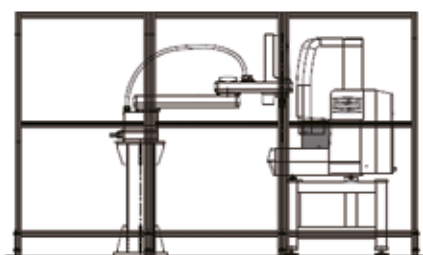
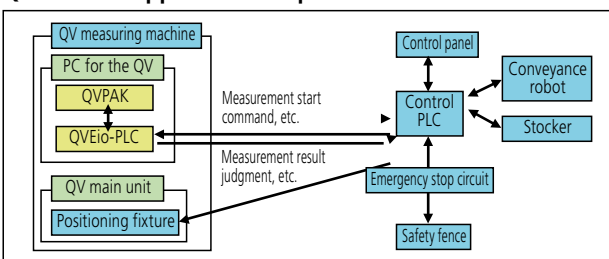

QVEio-PC

Not only can QVEio-PC be used to perform control through RS-232C communication with an external PC but it can also be used to output measurement results and the status of errors that occur on the QV. This makes it possible to control the QV efficiently. QVEio-PC is optimal for controlling the QV from a dedicated GUI on an external PC.

Main control commands

External PC

- Reading the operation status of the QV
- ABS execution command
- Measurement start command
- Reading measurement result file
- X-, Y-, Z-axis movement command
- Reading stage position information
- Each command

QVEio-PC

- Operation status output
- ABS execution in progress or ABS complete
- Measurement in progress or measurement complete
- Measurement result file output
- X-, Y-, Z-axis movement in progress or X-, Y-, Z-axis movement complete
- Stage position information output
- Error code output

QVEio-PLC supported example

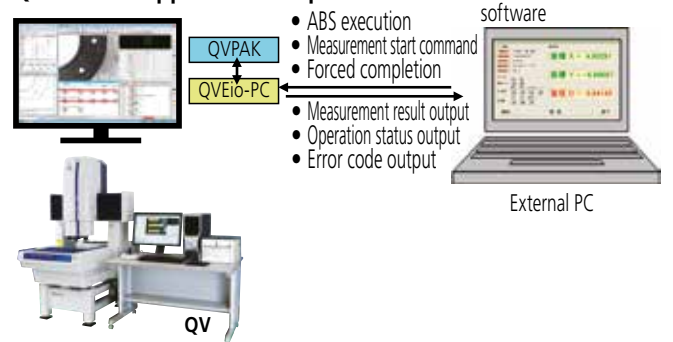

QVEio-Signal

QVEio-Signal notifies a PLC of the QV's operation status. QVEio-Signal is optimal for using a signal tower or similar device to display the operation status of the QV.

Measurement status output examples

- Measurement complete (standby)
- Measurement processing in progress
- Error occurrence
- Measurement complete message display
- Emergency stop error occurrence
- Reading or writing bit device data

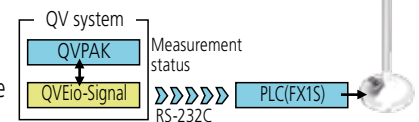



**Whatever your challenges are,
Mitutoyo supports you from start to finish.**

Mitutoyo is not only a manufacturer of top quality measuring products but one that also offers qualified support for the lifetime of the equipment, backed up by comprehensive services that ensure your staff can make the very best use of the investment.

Apart from the basics of calibration and repair, Mitutoyo offers product and metrology training, as well as IT support for the sophisticated software used in modern measuring technology. We can also design, build, test and deliver bespoke measuring solutions and even, if deemed cost-effective, take your critical measurement challenges in-house on a sub-contract basis.

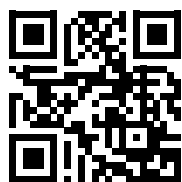

**Find additional product literature
and our product catalogue**

www.mitutoyo.eu

Note: MITUTOYO, MICAT, M-NanoCoord and QVPAK are either registered trademarks or trademarks of Mitutoyo Corp. in Japan and/or other countries/regions. MeasurLink is a registered trademark of Mitutoyo America Corp. in the United States and/or other countries/regions. Excel and Microsoft are either registered trademarks or trademarks of Microsoft Corporation in the United States and/or other countries. Other product, company and brand names mentioned herein are for identification purposes only and may be the trademarks of their respective holders. Product illustrations are without obligation. Product descriptions, in particular any and all technical specifications, are only binding when explicitly agreed upon.

Mitutoyo

Mitutoyo Europe GmbH

Borsigstraße 8-10
41469 Neuss

Tel. +49 (0) 2137-102-0
Fax +49 (0) 2137-102-351

info@mitutoyo.eu
www.mitutoyo.eu