

QUICK SCOPE

VISION MEASURING MICROSCOPES

FOR AUTOMATIC MEASUREMENT AND DOCUMENTATION

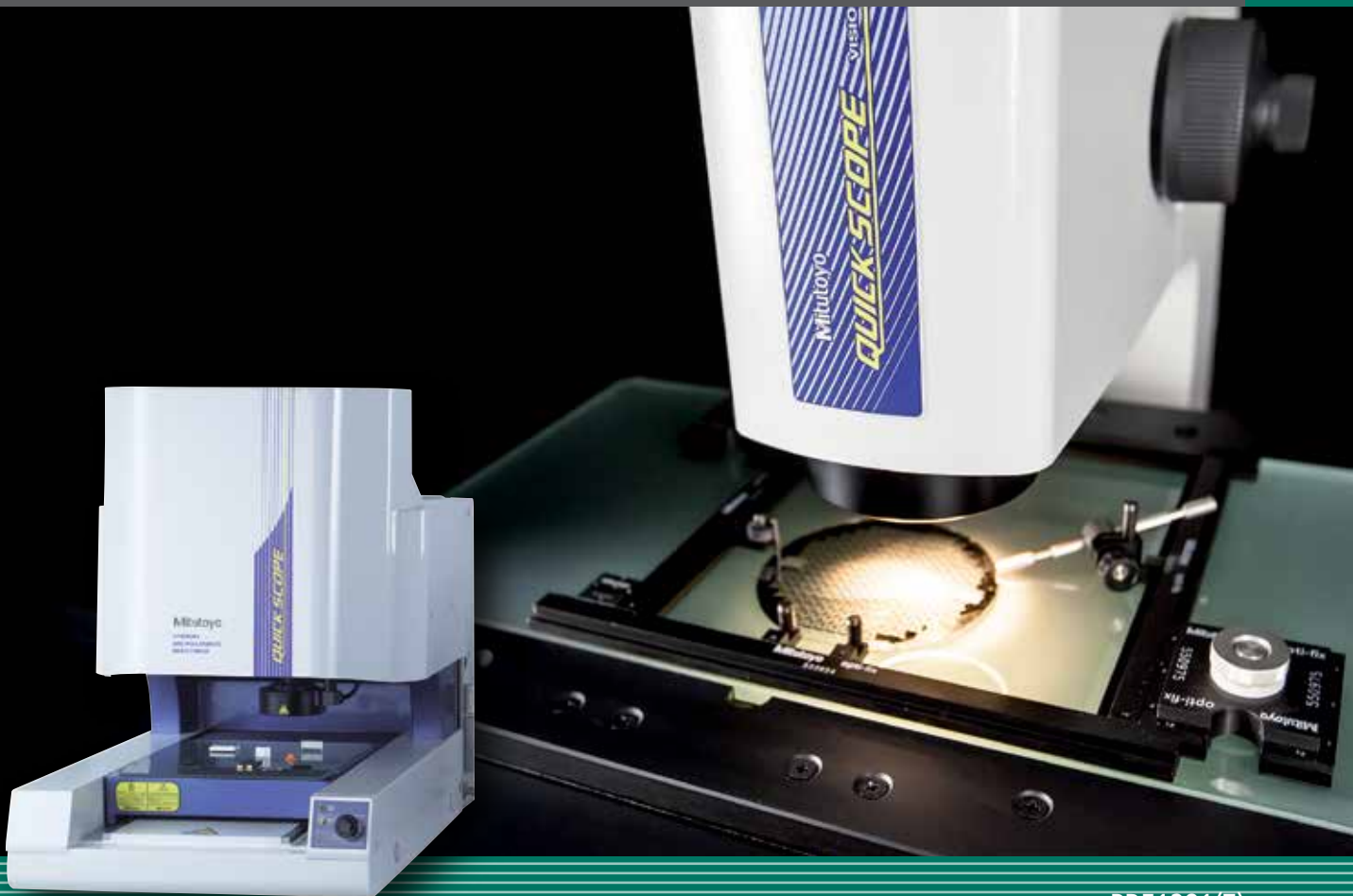

QUICK SCOPE: Quick, Convenient and Cost-effective

The QUICK SCOPE, available either as a manual or CNC version, enables reliable, contact-free precision measurements on parts and surfaces as well as vision profile testing.

Perceptibly smarter measurements

The projected workpieces can be rapidly and perfectly tested on screen with easy observation, navigation and measurement process definition. The machine comes with sophisticated software, and a quick algorithm ensures perfect edge recognition. Powerful image documentation is provided by the high-resolution colour CCD camera.

QUICK SCOPE is specially designed for workshop use, and means that the process of production testing, quality assurance and control can now start right there – in the workshop. The compact, mobile desktop devices are suitable for economically measuring both individual parts and series. QUICK SCOPE is supplied with the user-friendly image processing software QSPAK. All sequences such as lighting control, magnification or parts programming can be operated easily at the click of a mouse.

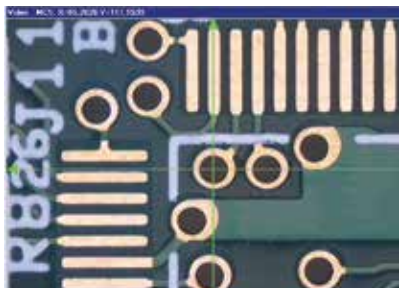
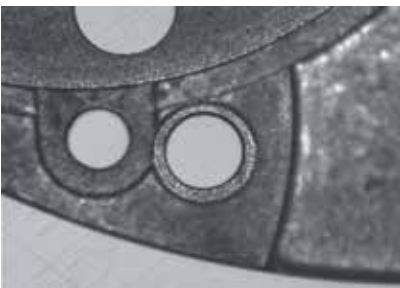

QUICK SCOPE

Manual / CNC

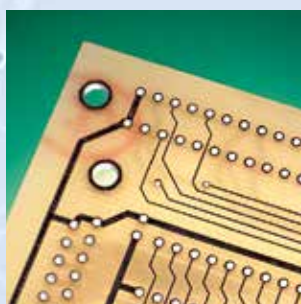
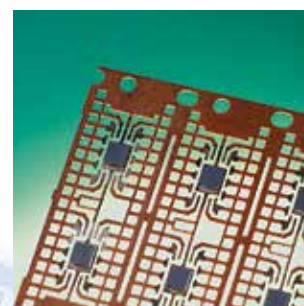

QUICK SCOPE: Two Concepts with Many Uses

Certain workpieces are difficult to take hold of because of their size, or are extra-sensitive to contact measurement. However, even these need to be measured safely and automatically. This field of application is the domain of contactless vision systems.

QUICK SCOPE, a vision microscope available both in a manual as well as CNC-controlled variant, has built-in flexibility. The manual variant is designed as a compact, economic desktop device for easy manual measurement of single parts. The CNC model, also a portable desktop system, is outstandingly suitable for the measurement of small and medium-sized series. The QUICK SCOPE series is recommended for use in a large number of industries. For example, in the following specific applications:

> Chemicals industry

- > Material testing of plastics
- > Determination of linear expansion

> Timber industry

- > Testing of contours, including for parquet flooring

> Medical industry

- > Testing of packaging

> Metal industry

- > Contour and geometrical measurements on sheet metal
- > Testing of shearing surfaces

> Motor vehicle industry

- > Testing of print masks for indicator instruments and operating elements

> Rubber and plastics industry

- > Contour and form measurement on sealing rings
- > Geometrical tests on the housings of mobile telephones
- > Testing of plastic gearwheels for ink jet printers

> Electronics industry

- > Line measurement of printed conductors and terminals on printed circuit boards



Testing of contours on parquet flooring

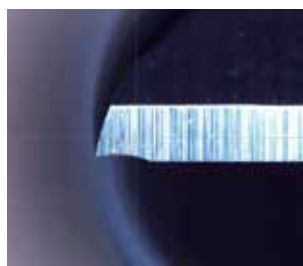

Cutting tool



Contour and geometrical measurements on sheet metal



Material testing of plastics



Line measurement of printed conductors and terminals on printed circuit boards



Contour and form measurement on sealing rings

QS Series

The Quick Scope series can be used for measurement in various industries for such products as molded-plastic parts, machined parts, cutting tools, and electronic components. Vision measuring software system QSPAK, that combines excellent operability with high functionality, aids customers in meeting measurement challenges. The additional use of application software FORMPAK-QV can extend QSPAK capabilities to enable form assessment and analysis.

QS-LZB



Drive method	Focus	Optical system	Image detecting unit
All axes: Manual	Contrast-level function	Zoom lens	CMOS colour camera

QS-L Z/AFB



Drive method	Focus	Optical system	Image detecting unit
XY: Manual Z: CNC	Auto focus	Zoom lens	CCD colour camera

QS

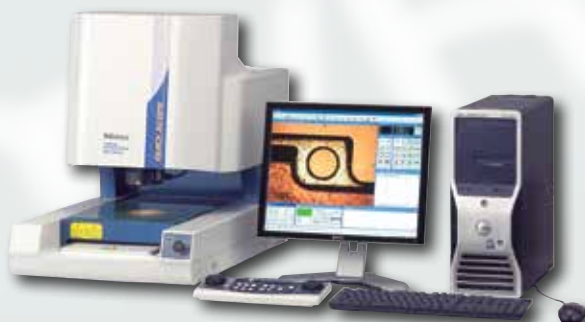

Drive method	Focus	Optical system	Image detecting unit
All axes: CNC	Auto focus	Zoom lens	CCD colour camera

Working Efficiently

Stage variations

The QS series stage offers an XY measuring range of 200×250 mm. The QS-L Z/AFB and QS-LZB stage lineup comprises three sizes with an XY measuring range of 200×100 mm, 300×170 mm and 400×200 mm, respectively.

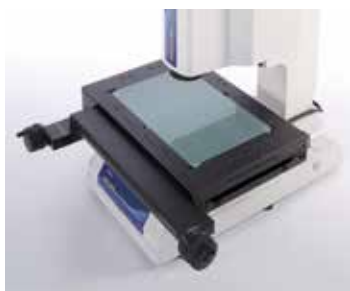

Quick release mechanism

Applicable models: QS-L Z/AFB, QS-LZB

A quick release mechanism is installed on the XY stage of those models. Stage feed can be switched between coarse and fine (FREE and LOCK). Since this mechanism puts the stage in a completely free state, it greatly eases moving the stage if it is a long way to the next measuring point.

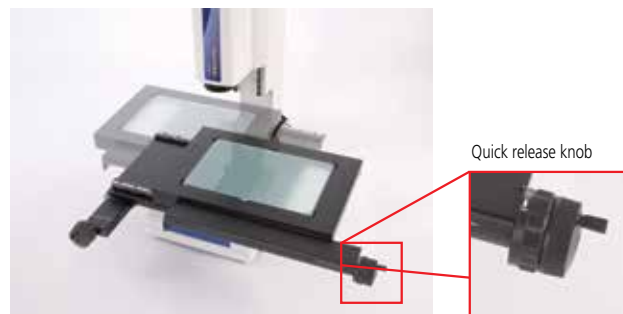

Illumination functions provide excellent support for measurement and observation

In addition to contour and surface illumination, Quick Scope is equipped with a fiber-optic ring light to aid in reproducing color images more clearly. This illumination enables measurement and observation of images under optimal conditions.

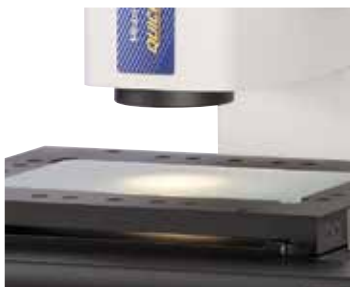

Contour (stage) illumination

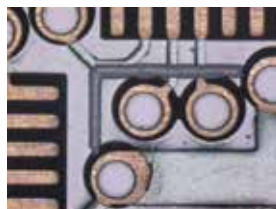

Surface (coaxial) illumination

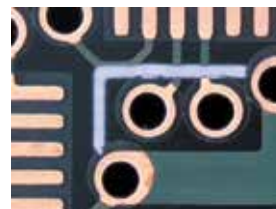

Fiber-optic ring illumination

Left and right knobs on the Z-axis feed mechanism

Applicable model: QS-LZB

Z-axis feed knobs are fitted on both sides of the column to avoid restricting the choice of focusing hand.

The outside coarse-feed knob adjusts the Z-axis 30 mm per revolution and the inside fine-feed knob feeds at 0.2 mm per revolution.

This type of dual-concentric coarse- and fine-feed control dramatically improves operability.

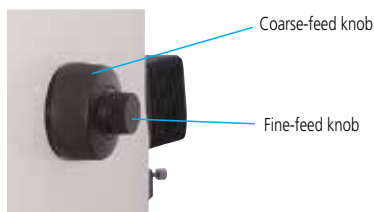

Autofocusing Tool (AF)

Applicable models: QS, QS-L Z/AFB

The AF (Auto focus) tool allows focusing without personal error, therefore achieving high-accuracy height measurement.

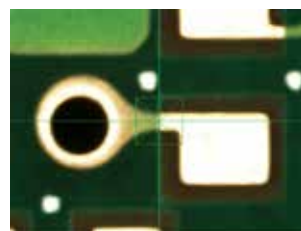

Image before AF

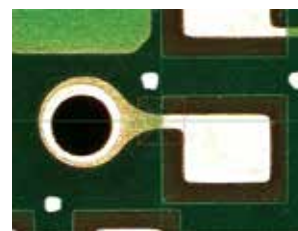

Image after AF

Programmable power zoom

Zooming from low to high magnifications can support your task from wide-field observation to high-magnification measurement without changing lenses. Additionally, the automatic light control function associated with a zooming operation and automatic correction functions, such as for image displacement and pixel calibration, are installed in these models.

QS, QS-L Z/AFB: 0.5X – 3.5X (26X – 180X) at 8 steps, 7X zoom

QS-LZB: 0.75X – 5.25X (28X – 202X) at 8 steps, 7X zoom

Each numeral in parentheses indicates the image magnification using a **56 cm** (22-inch) LCD monitor.

Image examples in QS-LZB

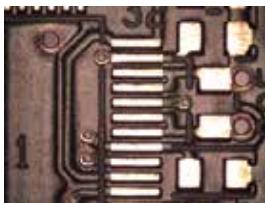

0.75X

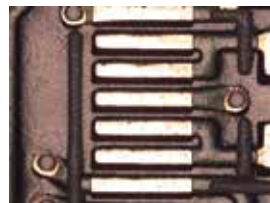

1.5X



3X

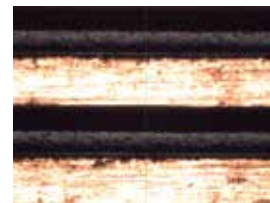

5.25X

Control box

Applicable models: QS, QS-L Z/AFB, QS-LZB

Frequently-used operations such as illuminating, data entry, zooming, and auto-focusing* can be performed with a single touch of individual buttons conveniently positioned near at hand. The CNC QS system allows remote operation with a jog shuttle. The manual QS system can be operated with a single touch of a button in the case of repeated measurement.

Function available only in QS and QS-L Z/AFB



For QS



For QS-L Z/AFB



For QS-LZB

Digital zoom function

Every click on the menu icon magnifies an image display from normal 1X to 2X and then 4X. An image can be measured by digital-zooming in every detail.

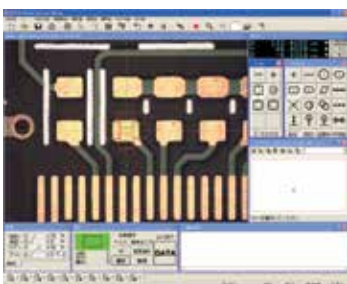

1X

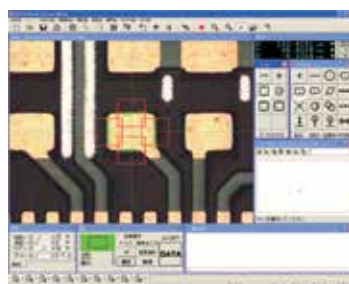

2X

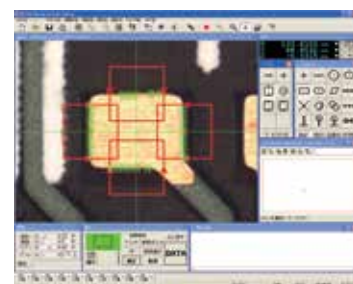

4X

Manual Vision Measuring Systems QS-LZB



QS-L2010ZB

Specifications

Model	QS-L2010ZB	QS-L3017ZB	QS-L4020ZB
Order No.	359-710-1D	359-711-1D	359-712-1D
Feed mechanism	Manual		
Observation unit	Zoom: 0.75X – 5.25X (8X in 7 steps)		
Range (X×Y×Z) mm	200 × 100 × 150 (8"×4"×6")	300 × 170 × 150 (12"×7"×6")	400 × 200 × 150 (16"×8"×6")
Resolution/ length standard	0.1 μm / Linear encoder		
Image detecting unit	3 MP colour CMOS camera		
Digital zoom	1X - 2X - 4X		
Measuring accuracy ¹	XY (2.5+0,02 L) μm [L= Measuring length in mm] Z (5+0,04 L) μm [L= Measuring length in mm]		
Stage glass size (mm)	250 × 150 (10"×6")	370 × 240 (15"×9")	440 × 240 (17"×9")
Maximum stage loading	10 kg (22 lbs.)	20 kg (44 lbs.)	15 kg (33 lbs.)
Illumination	Contour illumination: 12 V/50 W halogen, Surface illumination: 12 V/50 W halogen Fiber-optic ring light: 12 V/100 W halogen		
Dimensions ² (W×D×H) mm	Main unit: 624 × 769 × 722 (25"×30"×28") Control unit:	Main unit: 682 × 916 × 837 (27"×36"×33") Control unit:	Main unit: 757 × 931 × 837 (30"×37"×33") Control unit:
Mass	Main unit: 72 kg (160 lbs.)	Main unit: 140 kg (311 lbs.)	Main unit: 146 kg (324 lbs.)
Power unit	5 kg (11 lbs.)		
Power consumption	160 W at max (Only of QS main unit, excluding PC set)		

¹ Company standard (zoom magnification: 3X) under an installation environment of 20°C and during use of the standard lens

² The width and height increase by a maximum of X-axis stroke and Z-axis stroke, respectively. The depth increases by one half of the Y-axis stroke at most.

Improved manual focusing repeatability

An indication of image contrast near the center of the video window is displayed on a level meter. A peak level indicates a focal position. This improves the repeatability of focal positions in manual focusing.



Before focusing



After focusing

QS-LZB

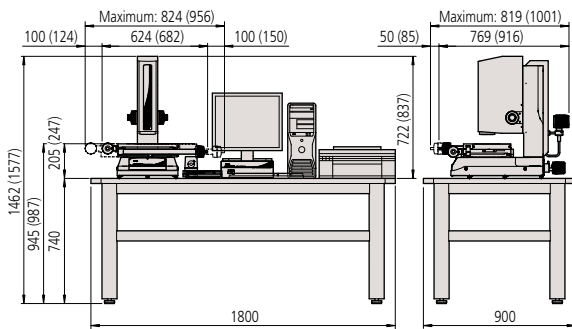

Dimensions in parentheses indicate those for model 3017.

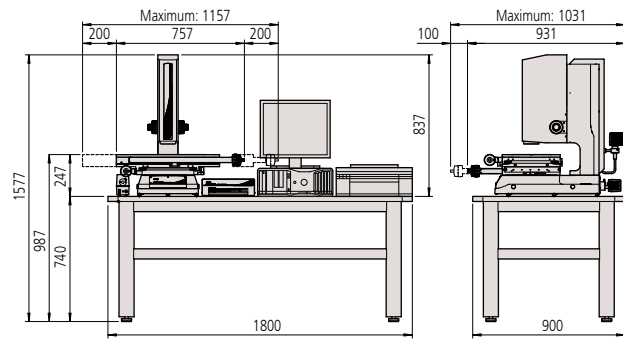

Model 4020

System diagram

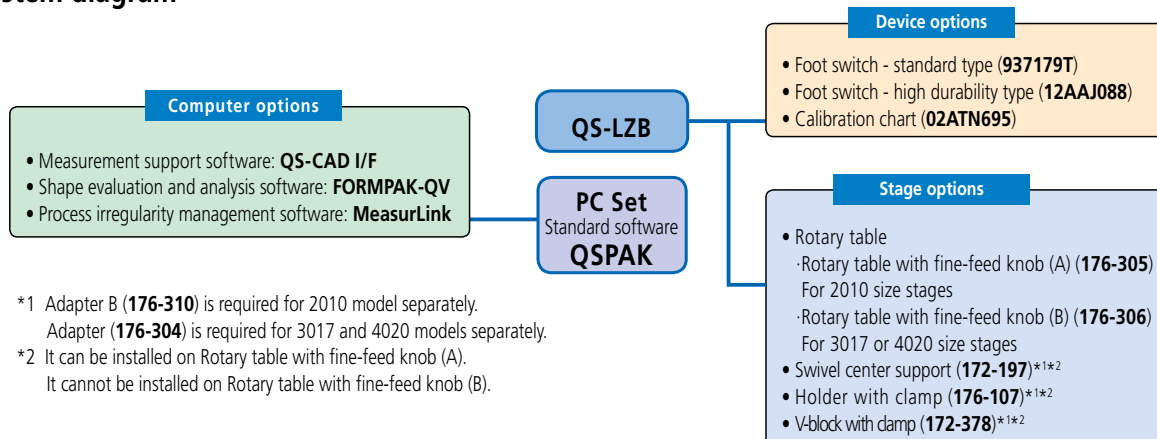

- *1 Adapter B (**176-310**) is required for 2010 model separately.
Adapter (**176-304**) is required for 3017 and 4020 models separately.
- *2 It can be installed on Rotary table with fine-feed knob (A).
It cannot be installed on Rotary table with fine-feed knob (B).

Optical system magnification ratios available for QS-LZB

Total magnification	29X	38X	49X	58X	87X	116X	145X	202X
Field of View (mm)	8.8×6.6	6.8×5.1	5.2×3.9	4.4×3.3	2.9×2.2	2.2×1.6	1.7×1.3	1.2×0.9
QS-LZB	0.75X	0.98X	1.28X	1.5X	2.25X	3X	3.75X	5.25X
Working distance (mm)	55							

* Total magnification shown in the above table is a reference value displayed in the default window state when using 22-inch wide LCD monitor.

Manual Vision Measuring Systems QS-L Z/AFB



Specifications

Zoom lens system	Model Order No.	QS-L2010Z/AFB 359-703D	QS-L3017Z/AFB 359-704D	QS-L4020Z/AFB 359-705D
Feed mechanism		XY-axis: manual / Z-axis: motor-driven with auto-focus		
Range (X×Y×Z)		200 × 100 × 150 mm	300 × 170 × 150 mm	400 × 200 × 150 mm
Resolution / length standard		0.1 μm / Linear encoder		
Image detecting unit		Colour CCD camera		
Measuring accuracy*1	XY	(2.5+0,02L) μm [L= Measuring length in mm]		
	Z	(5+0,006L) μm [L= Measuring length in mm]		
Stage glass size (mm)		250 × 150 (10"×6")	370 × 240 mm	440 × 240 mm
Maximum stage loading		10 kg (22 lbs.)	20 kg (44 lbs.)	15 kg (33 lbs.)
Illumination		Contour Illumination: 12 V/30 W Halogen Reflected Illumination: 12 V/50 W Halogen Fiber-optic ring light: 12 V/100 W Halogen		
Dimensions*2 (W×D×H)	Main unit	624 × 705 × 722 mm	682 × 852 × 837 mm	757 × 86 × 837 mm
	Power unit	186 × 452 × 381 mm		
Mass	Main unit	66 kg (147 lbs.)	134 kg (298 lbs.)	140 kg (311 lbs.)
	Power unit	14 kg (31 lbs.)		
Power consumption		400 W at max. (Only of QS main unit, excluding PC set)		

*1 Company standard (zoom lens system: 2.5X at the time of zooming in) under an installation environment of 20°C and during use of the standard lens

*2 The width and height increase by a maximum of X-axis stroke and Z-axis stroke, respectively. The depth increases by one half of the Y-axis stroke at most.

Dimensions

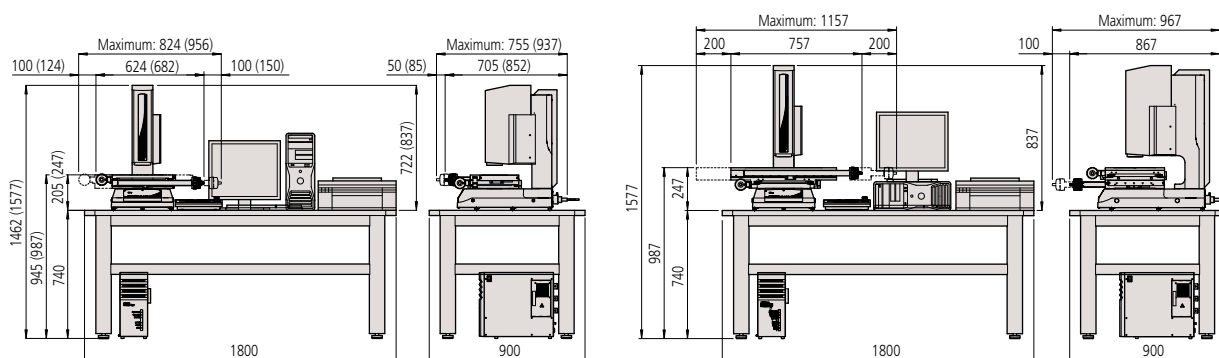

Dimensions in parentheses indicate those for model 3017.

Model 4020

System diagram

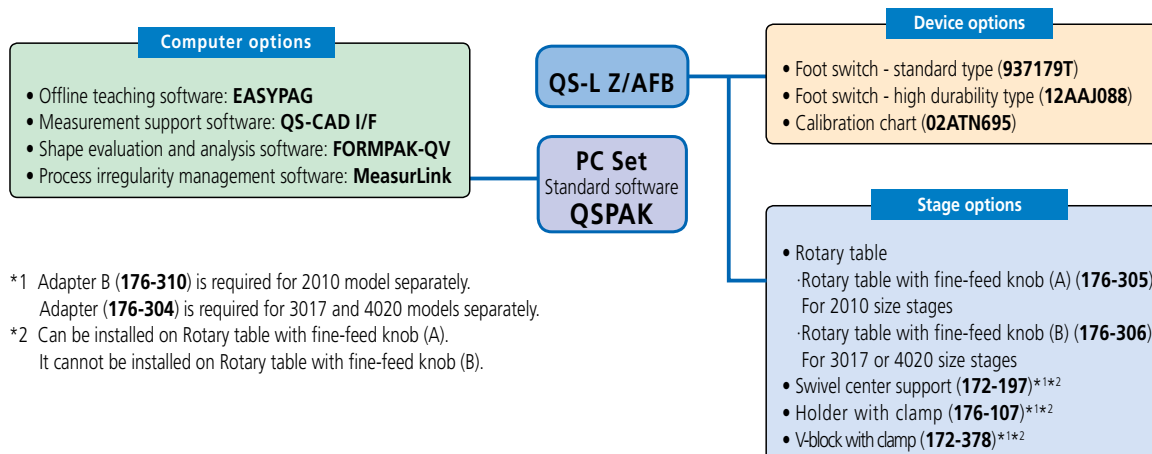

- *1 Adapter B (**176-310**) is required for 2010 model separately.
Adapter (**176-304**) is required for 3017 and 4020 models separately.
- *2 Can be installed on Rotary table with fine-feed knob (A).
It cannot be installed on Rotary table with fine-feed knob (B).

Optical system magnification ratios available for QS-L Z/AFB

Total magnification	26X	34X	44X	52X	78X	103X	129X	180X
Field of View (mm)	9.5×7.1	7.3×5.4	5.6×4.2	4.7×3.5	3.1×2.3	2.3×1.7	1.9×1.4	1.3×1.0
QS-L Z/AFB	●	●	●	●	●	●	●	●
Working distance (mm)	0.5X	0.65X	0.85X	1X	1.5X	2X	2.5X	3.5X
				55				

* Total magnification shown in the above table is a reference value displayed in the default window state when using 22-inch wide LCD monitor.

CNC Vision Measuring System QS



Specifications

Zoom lens system	Model Order No.	QS250Z 359-508-10Y
Drive method		CNC
Range (X×Y×Z) mm		200 × 250 × 100 (8"×10"×4")
Resolution/ length standard		0.1 μm /Linear encoder
Image detecting unit		Colour CCD camera
Measuring accuracy*1	XY	(2.5+ 0.006) μm [L= Measuring length in mm]
	Z	(5+ 0.006) μm [L= Measuring length in mm]
Drive speed		Max 80 mm/s
Acceleration and deceleration		Max. 250 mm/s ²
Stage glass size		269 × 311 (11"×12")
Maximum stage loading		10 kg (22 lbs.)
Illumination		Contour Illumination: 12 V/30 W Halogen Reflected Illumination: 12 V/50 W Halogen Fiber-optic ring light: 12 V/100 W Halogen
Dimensions (W×D×H) mm		465 × 815 × 663 (18"×32"×26")
Mass		76 kg (169 lbs.)
Power consumption		500W at max (Only of QS main unit, excluding PC set)

*1 Company standard (zoom lens system: 2.5X at the time of zooming in) under an installation environment of 20°C and during use of the standard lens

Dimensions

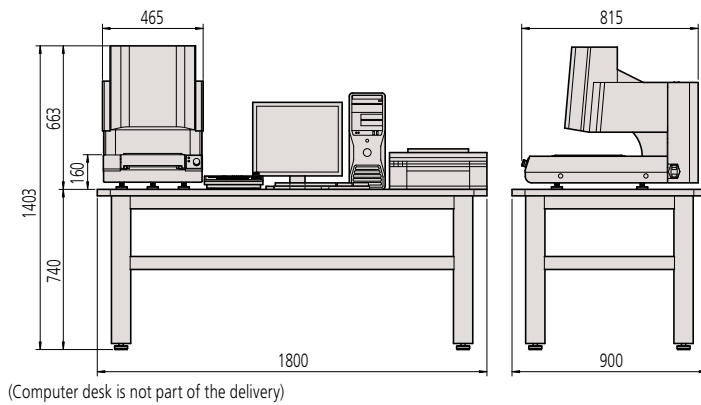

System diagramm

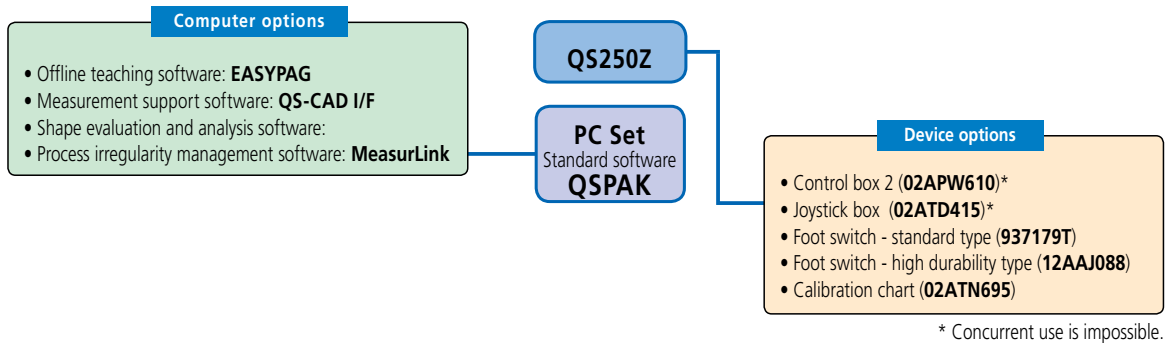

Optical system magnification ratios available for QS

Total magnification	26X	34X	44X	52X	78X	103X	129X	180X
Field of View (mm)	9.5x7.1	7.3x5.4	5.6x4.2	4.7x3.5	3.1x2.3	2.3x1.7	1.9x1.4	1.3x1.0
QS	0.5X	0.65X	0.85X	1X	1.5X	2X	2.5X	3.5X
Working distance (mm)	55							

* Total magnification shown in the above table is a reference value displayed in the default window state when using 22-inch wide LCD monitor.

QSPAK – A powerful vision measuring software system that supports a wide variety of measurement



In order to support various measuring methods from measurement of a wide variety of single parts to CNC measurement of mass production parts, QSPAK has achieved both high-reliability vision detecting capability and user-friendly operability.

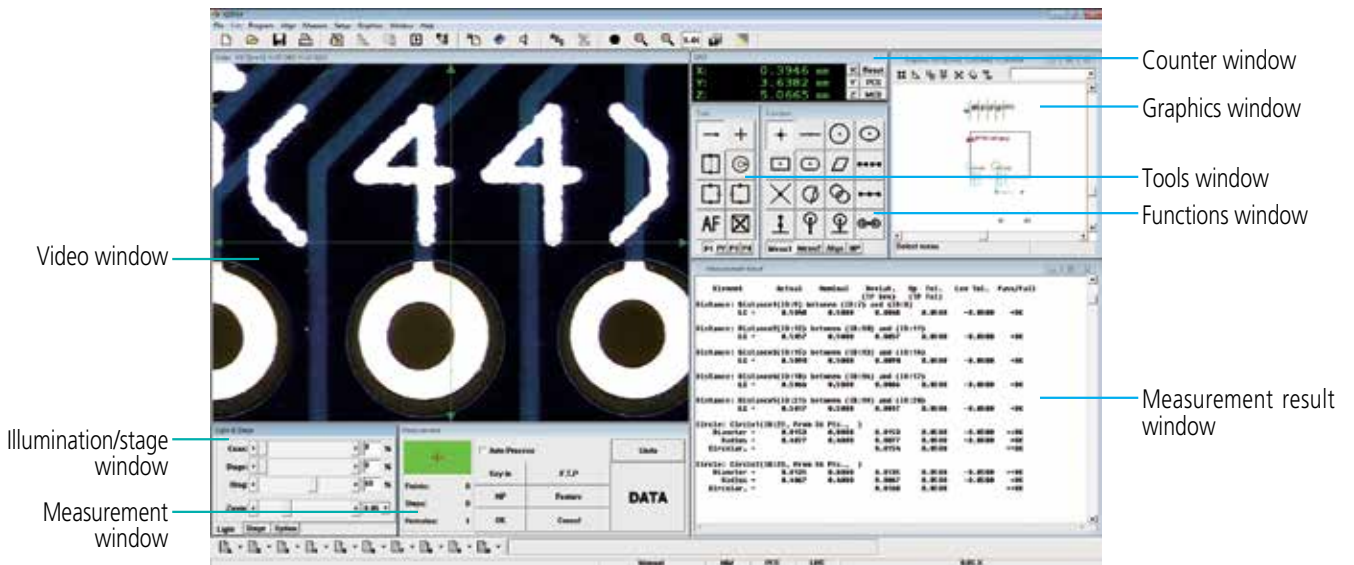

Measurement Commands Covering Basic Methods of Measurement

Coordinate system creation commands



Measurement item commands

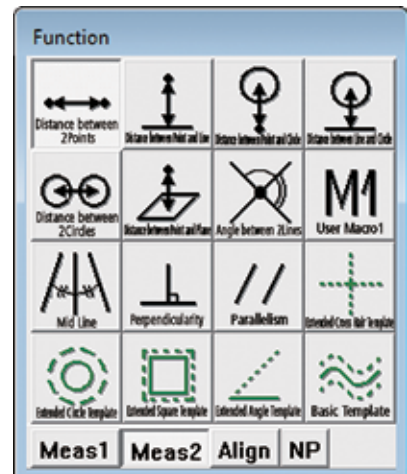
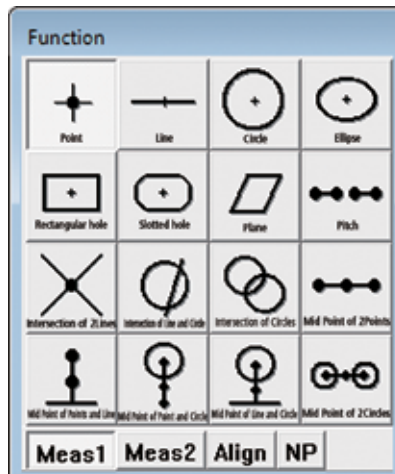

* Item names are not actually displayed, but displayed as on-line help.

One-click tools

(Patent pending in Japan)

A single click in the vicinity of a workpiece edge allows automatic processing from tool setting to edge detection/calculation. Additionally, this function does not need stage movement for any workpiece measurement within a screen, drastically reducing measurement time.

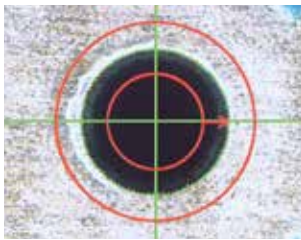

One-click circle tool

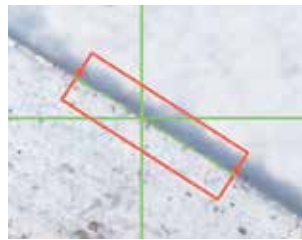

One-click box tool

Smart tool

(Patent pending in Japan)

The smart tool automatically detects the clearest edge within the range enclosed with a circle, thus allowing speedy edge detection compared with edge alignment using the cross hairs of a microscope or profile projector.

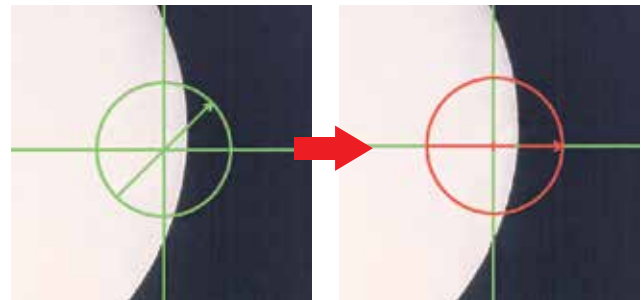

Auto-trace tool

This is a tool for form measurement in which the edge of an arbitrary form is detected with multiple points at a time.

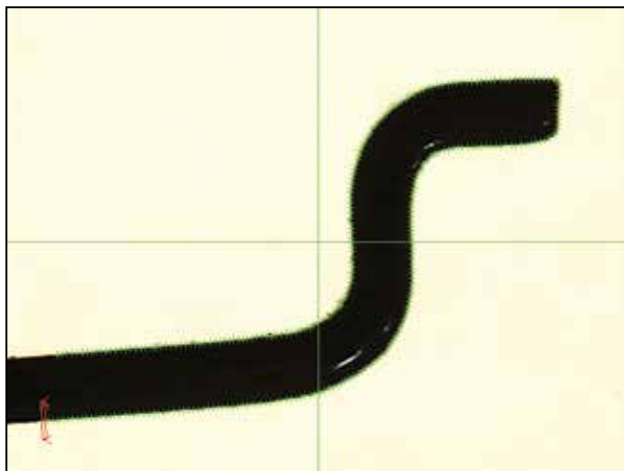

The Auto-trace tool of QS-L Z/AFB or QS-LZB only functions within a screen.

Light tool

The brightness tool is for setting illumination so as to match the screen brightness between the times during part program creation and part program execution. The dual area contrast tool is a tool for automatically setting the light intensity so as to maximize the contrast of edge areas.



Brightness tool

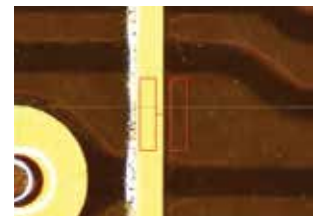

Dual area contrast tool

Datum Circle Measurement

In addition to calculating mean-circle measurements using the standard least-square method, the QS series can also perform calculations based on interior diameter (maximum inscribed circle) and external diameter (minimum circumscribed circle). This measurement approach is useful for circle measurement of the contact sides of fitted components, etc.

Convenient tools effective for visual measurement

Basic templates

The following are three basic templates corresponding to the reticle of a microscope.

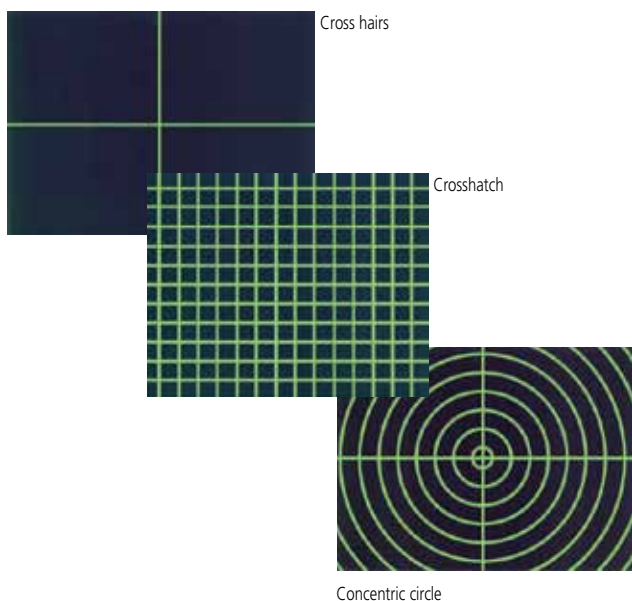

User pattern matching

The user can freely create a template (master) in accordance with a workpiece, different from the basic templates and extension templates to perform tolerancing with a master. Also, the user can easily perform tolerancing by displaying key-entered upper limit and lower limit lines on the screen.

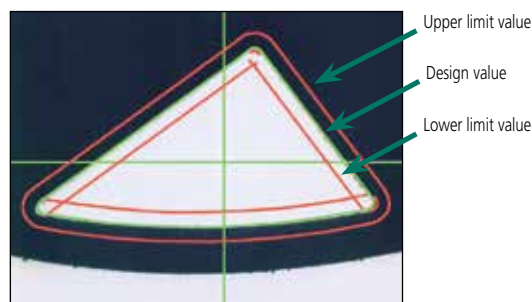

Extension templates

Extension templates are provided based on four types of pattern: cross-hair; circle; rectangle; and angle. A diameter, distance, angle, and other value can freely be set by key entry in the same manner as used in comparison measurement with a profile projector.

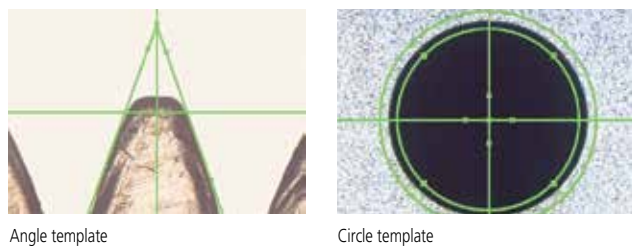

CAD user template function

This function allows a template to be created using a form (CAD data) in the Graphics window.

To create a template, CAD data needs to be imported and exported.

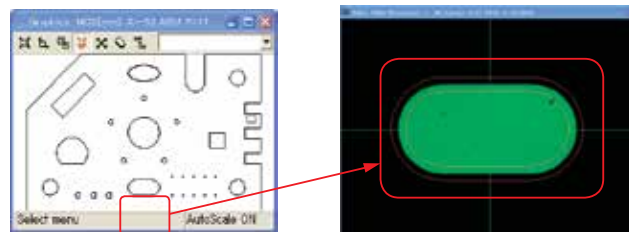

One-click simple execution function – program launcher

An auto-measurement procedure program can be associated with a dedicated icon along with a photo and comments to enable a program to be started by a single click. A total of 10 icons are provided and programs can be managed for each operator or workpiece using these icons.

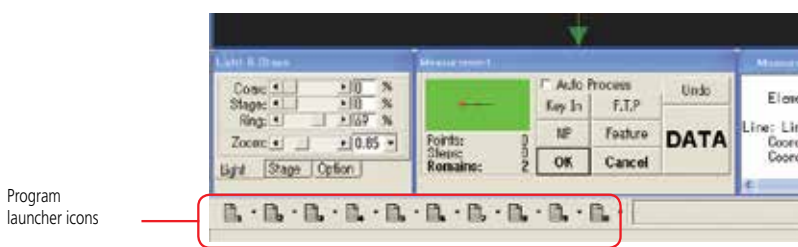

Program launcher icons

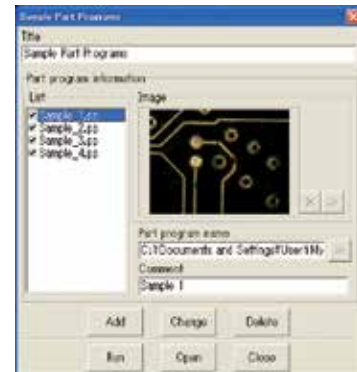

Auto-measurement procedure program association window

Smart editor

This function allows an XY-stage travel position, lens magnification, illumination condition, etc., to be separately displayed as icons or labels in the list of part programs (auto-measurement procedure programs), thereby simplifying program edition.

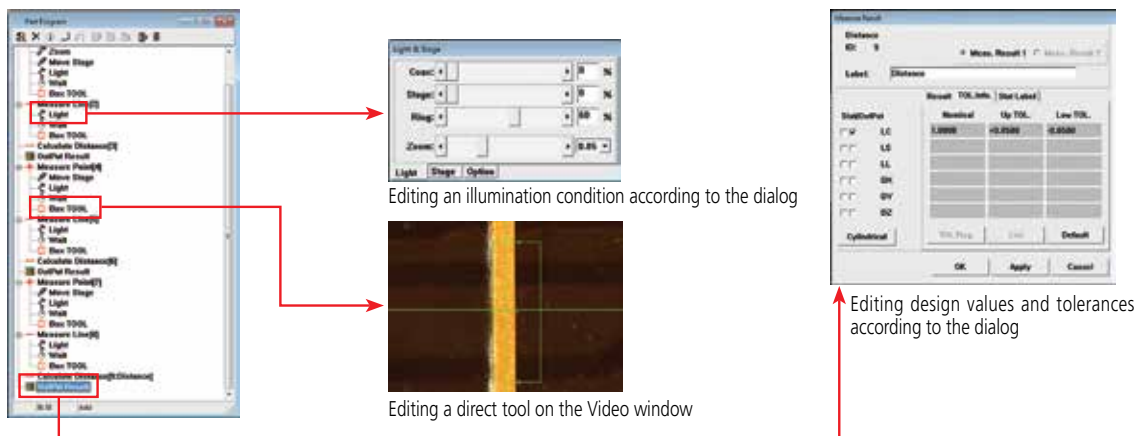

Convenient Functions to Simply Execute and Edit an Auto-measurement Procedure Program

Navigation function contributes to reduction in measurement time

Stage navigation (QS)

(Patent registered in Japan)

This stage navigation function enables pinpoint positioning when the stage needs to be moved significantly. To move the stage, click the point in the graphics window to which the stage is to be repositioned. Then, the stage directly moves to the point. This can suppress wasted stage motion such as overrun or deficient run to the minimum. To accurately move the stage, click a point to move to the center of the video window with the mouse. Then, the stage accurately moves to the center of the video window. The use of this function will significantly reduce the creation time needed for a part program.

Stage movement with the graphics window

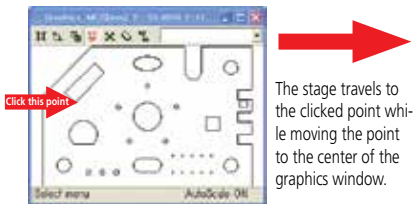

Stage movement with the video window

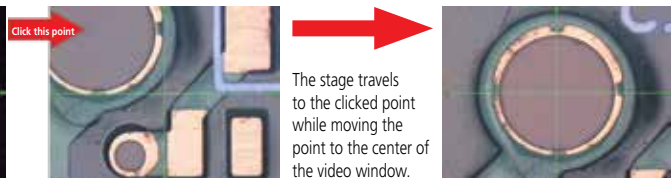

Quick navigation (QS-L Z/AFB, QS-LZB)

(Patent registered in Japan)

This is a navigation function that concurrently uses the learn/ repeat function for storing and reproducing a series of measuring procedures. This function navigates the operator to the next measuring point in accordance with the measuring procedure stored. Move the stage until the red cross-hairs indicating the next measuring point coincide with the green cross-hairs at the center of the monitor screen. Then, the view at the next measuring point will appear on the screen. This function also allows zero approach using the digital counter. The operator does not need to check a measuring point while looking at a workpiece and can perform measurement while concentrating on the screen.

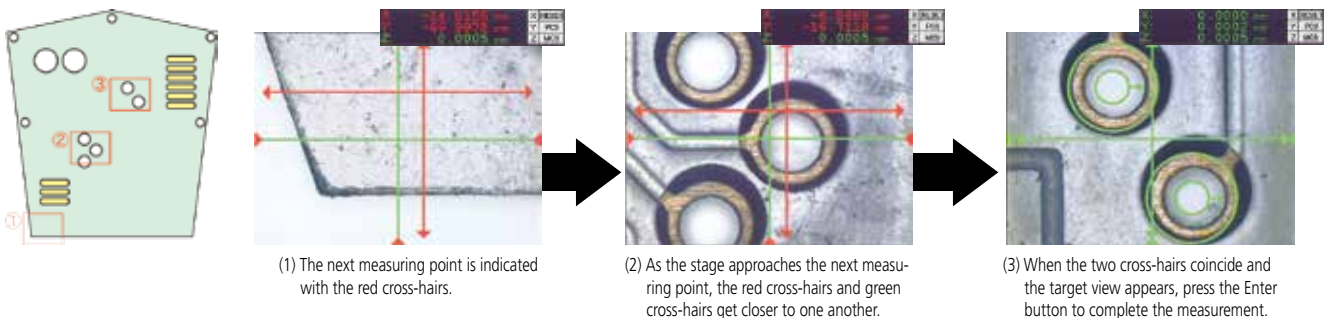

Enhanced capabilities supporting tasks from operator management to inspection report creation

Graphics window

Measuring features and measurement results are displayed in real time on the graphics window. This allows the operator to verify measurement points with visual images. Measuring features can also be selected from graphics, thus allowing speedier measurement. Calculation between features is possible using the graphics window.



Icon editor

The layouts of measurement item icons, tool icons, etc., can freely be rearranged. The operator can apply free icon configuration in which, for example, frequently-used icons are grouped on the first page.



Security function

This function restores the range of use depending on the task level by requesting password entry when QSPAK® starts up.



Video image scale display

Scales in accordance with the actual field of view can be displayed on the video window to quickly estimate size of a workpiece. If workpiece images are stored along with scale indication, it gives a rough indication of the size of each workpiece.



Image storage

Color images on the video window can be output as a file in BMP or JPG format. Also, the images can easily be attached to the record of workpiece graphics, inspection report, etc.



Measurement report

Measurement results obtained by a part program can be output as they are in CSV format. Since the results are output to commercial spreadsheet software such as Excel, you can create a company-specific inspection report.



Optional Software

Lineup of Application Software to Meet Advanced Measurement Requirements

Form assessment and analysis software

FORMPAK-QV

This software can perform contour analysis and tolerancing with design values from multi-point data acquired with the auto-trace tool, etc.

The auto-trace tool for the QS-L Z/AFB or QS-LZB only functions within a screen.

Examples of fine dimension analysis

- The dimensions of fine shapes displayed on-screen can be measured using intuitive controls.

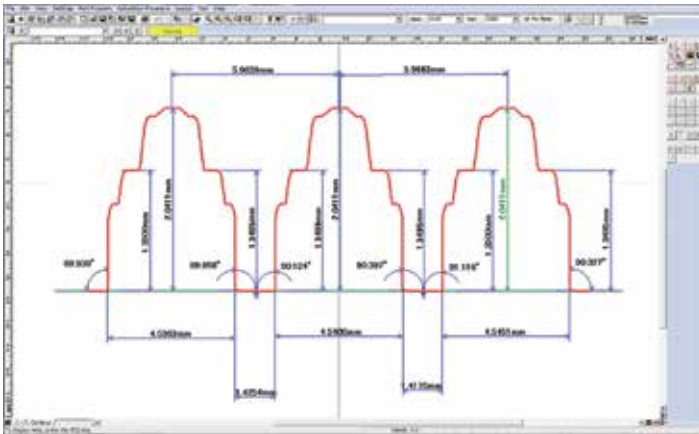

Contour analysis screen

Example of gear contour matching and overpin diameter analysis

- The software can be used to perform contour matching against the design value data.
- You can define virtual circles of any desired diameter.

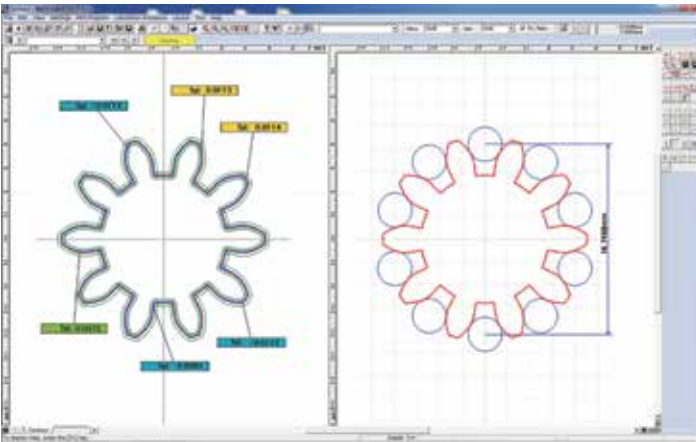

Contour tolerance screen

Contour analysis screen

Measurement support software

QS-CAD I/F

CAD data created during the design phase (DXF- or IGES-formatted) can be imported into QSPAK.

QSPAK measurement results can also be converted into CAD data.

Features

- The design value for each measurement item is automatically entered.
- The stage can be quickly moved to a given point in the CAD data.
- Graphic data can be output in a specified CAD format.

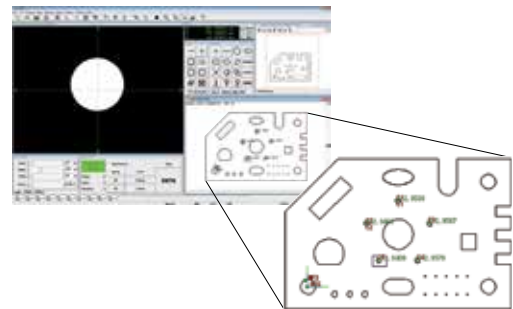

Process irregularity management software

MeasurLink

Statistical data can be displayed in real-time, making early detection of process irregularities possible. Data change-points can be analyzed in order to identify problems, and swiftly implement prevention measures when the problems are part of a trend.

Usage examples

- Mold adjustment and replacement timing measures
- Cutting tool adjustment and replacement timing measures, etc.

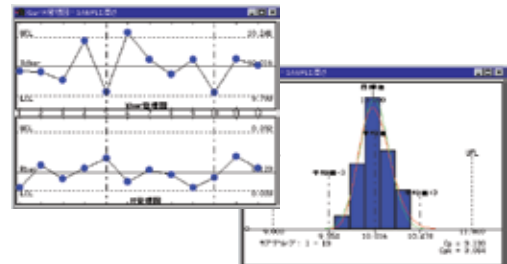

Optional Accessories



Rotary table with fine-feed knob (A)	
Order No.	176-305
Dimensions	280 (W) x 280 (D) x 24 (H) mm Table-top surface No reading scale of 360° rotation angle
Mass	5.5 kg
Stage-glass effective diameter	178 mm
Applicable model	QS-L Z/AFB, QS-LZB

NOTE: V block with clamp, swivel center support, and holder with clamp can be secured on the table.



Rotary table with fine-feed knob (B)	
Order No.	176-306
Dimensions	342 (W) x 342 (D) x 23 (H) mm Table-top surface No reading scale of 360° rotation angle
Mass	6.5 kg
Stage-glass effective diameter	235 mm
Applicable model	QS-L Z/AFB, QS-LZB

NOTE: V block with clamp, swivel center support, and holder with clamp can be secured on the table.

• Calibration chart

This chart is used for correcting the pixel size of image detection. In zoom lens systems, it is also used for zoom offset calibration that corrects an optical axis offset.



02ATN695 (with holder)
02AKN020

• QS correction chart

This is a glass chart for correcting on-screen distortions specific to an optical system.



02AKW001 (with holder)
02AKW005

The photo shows the chart with holder.



Stage Adapter	
Order No.	176-304 / B: 176-310
Dimensions 1 piece	50 (W) x 340 (D) x 15 (H) mm NOTE: 280 (D) mm for adapter B
Mass	1.5 kg / B: 1.2 kg
Applicable model	QS-L Z/AFB, QS-LZB

NOTE: 2 pieces per set



Joystick box	
Order No.	02ATD415
Applicable model	QS



Foot switch	
Order No.	937179T
Applicable model	QS, QS-L Z/AFB, QS-LZB

Standard accessory only for QS-EB



Ruggedized-type foot switch	
Order No.	12AAJ088
Applicable model	QS-L Z/AFB, QS-LZB



V block with clamp	
Order No.	172-378
	Maximum holding diameter: 25 mm Center height from mounting face: 38 to 48 mm
Dimensions	117 (H) x 90 (W) x 45 (D)mm
Mass	0.8 kg
Applicable model	QS-L Z/AFB, QS-LZB

Used in combination with stage adapter B (176-310) or rotary table A (176-305).



Swivel center support	
Order No.	172-197
	Variable inclined posture within $\pm 10^\circ$, minimum reading of angle: 1° Optimal for measurement of screws, etc. Maximum possible holding dimensions: $\phi 80 \times 140$ mm in horizontal posture Maximum possible holding dimensions: $\phi 65 \times 140$ mm in 10° inclined posture
Mass	2.5 kg
Applicable model	QS-L Z/AFB, QS-LZB

Used in combination with stage adapter B (176-310) or rotary table A (176-305).



Holder with clamp	
Order No.	176-107
Maximum length of clamp	35 mm
Dimensions	62 (H) x 152 (W) x 38 (D) mm
Mass	0.4 kg
Applicable model	QS-L Z/AFB, QS-LZB

Used in combination with stage adapter B (176-310) or rotary table A (176-305).

Optional Accessories

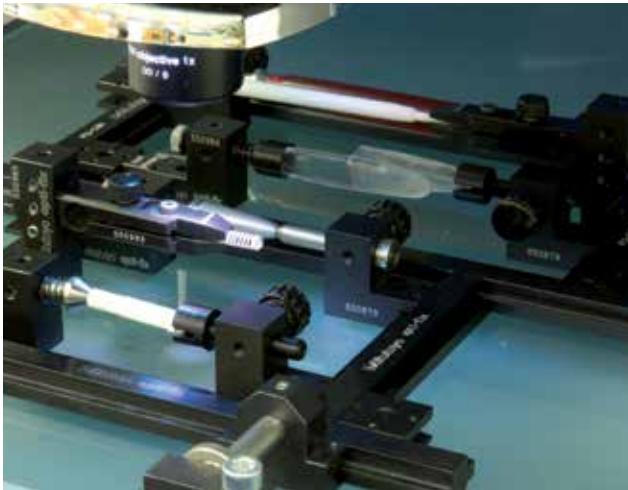

Mitutoyo opti-fix

The opti-fix system allows the quick and safe solution of very different tasks using only a few components. In case of measuring methods using reflected as well as transmitted light for measurement of cubic, rotationally symmetrical and especially flat workpieces, the use of opti-fix is a really practical solution. Furthermore, the spring clips and centering pins of different design which are integrated in the system allow also tactile measuring. Mitutoyo opti-fix offers the user a large number of possibilities for part fixing, from clamping tweezers for miniature test specimens to precision vice for large parts.

Mitutoyo opti-fix round

Mitutoyo opti-fix round. The innovative, newly developed Komeg tool "Mitutoyo opti-fix round" completes the opti-fix types in the true sense of the word "the wheel comes full circle".

The circular design allows an infinitely variable adjustment of 360° in horizontal level as well as in space and additionally, the "pin fixing" at the sides ensures a user-friendly access to the workpiece.

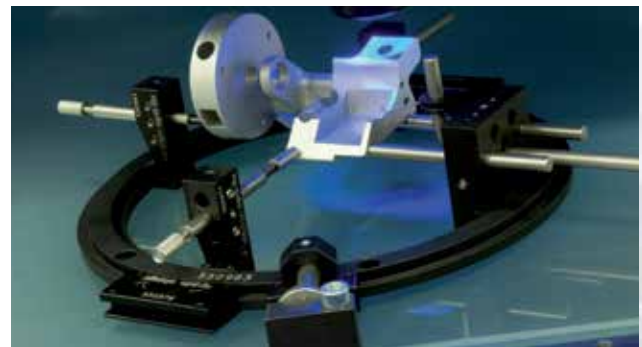

Another Gauge to Measure your Partners: Competent advice and service

Anyone who performs precision work needs a partner with sharp vision. Not only in the development and supply of the ideal measuring system, but also in front and behind – with advice and service. As a manufacturer of measuring machines with one of the world's broadest range of products and over seven decades of experience, Mitutoyo has a particularly refined range of services. For absolute customer satisfaction long before and for a long time after the decision to purchase.

Advice

Depending on your requirements, you can define, in close dialogue with the Mitutoyo specialist consultants, the machine or system selection to fit your specific measuring tasks – either standard or special tailor-made solutions in the context of the revolutionary M3 solution concept from Mitutoyo. This guarantees that you will be

operating with the most suitable measuring equipment, both in terms of technical aspects and cost. As the sole complete supplier in its sector, Mitutoyo is well placed to configure the most efficient and suitable systems for you.

Service

DAkkS accredited calibration laboratory; central service workshop; large machine repairs on site at the customers' premises; contract measuring in all orders of magnitude; professional maintenance including using online systems; training and ongoing training at the Mitutoyo Information Center of Metrology (MIM); comprehensive information and data pools in online product lounges; competent service hotlines; contacts at your

Mitutoyo customer centres. With all this, you can be sure that you have made the right choice with Mitutoyo – and we can be sure of being able to satisfy your needs completely, well into the future. Because that, at the end of the day, is the standard against which you will measure your machine suppliers. After all, technical perfection goes without saying – at least from Mitutoyo.





**Whatever your challenges are,
Mitutoyo supports you from start to finish.**

Mitutoyo is not only a manufacturer of top quality measuring products but one that also offers qualified support for the lifetime of the equipment, backed up by comprehensive services that ensure your staff can make the very best use of the investment.

Apart from the basics of calibration and repair, Mitutoyo offers product and metrology training, as well as IT support for the sophisticated software used in modern measuring technology. We can also design, build, test and deliver bespoke measuring solutions and even, if deemed cost-effective, take your critical measurement challenges in-house on a sub-contract basis.

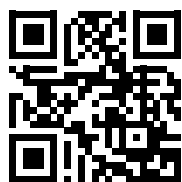

**Find additional product literature
and our product catalogue**

www.mitutoyo.eu

Note: Product illustrations are without obligation. Product descriptions, in particular any and all technical specifications, are only binding when explicitly agreed upon.
MITUTOYO and MiCAT are either registered trademarks or trademarks of Mitutoyo Corp. in Japan and/or other countries/regions.
Other product, company and brand names mentioned herein are for identification purposes only and may be the trademarks of their respective holders.

Mitutoyo

Mitutoyo Europe GmbH

Borsigstraße 8-10
41469 Neuss

Tel. +49 (0) 2137-102-0
Fax +49 (0) 2137-102-351

info@mitutoyo.eu
www.mitutoyo.eu