

## SURFTEST SJ-210/310 SERIES

Portable Surface Roughness Tester



Portable Surface Roughness Tester

# Surftest SJ-210/310 Series

## Compact but Highly Functional

These surface roughness testers with refined user-friendliness have been a customer favorite for many years.

### Surftest SJ-210 Series

The exceptionally convenient and compact surface roughness tester that can be carried around like a handheld tool, perfect for on-site use.

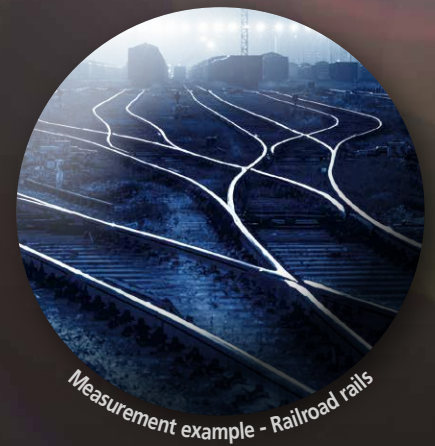



*With constant use throughout many industries for over 20 years, the SJ Series has been recognized as the pioneers of compact surface roughness testers!*

*With overwhelming performance, they contribute to manufacturing all over the world.*

## Surftest SJ-310 Series

A compact surface roughness tester that not only has superior functionality and portability but also a built-in printer.



## Tackle Your Challenges With the **SJ-210/310** Series!

### Case 1

#### Not content with your current tester?

I require a device that clearly displays roughness during measurement and prints the results quickly.

### Case 2



#### Fed up with transporting the workpieces to a stationary device?

Carrying workpieces to the inspection room a time-consuming pain.

I need a way to measure different surfaces on the workpiece without moving it around.

### Case 3



#### Don't own a surface roughness measuring machine?

Measuring roughness seems difficult...

Can I do it myself?

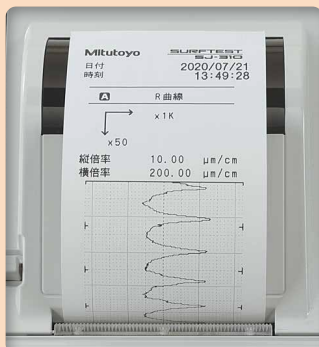

### With the **SJ-210/310 Series...**

You can measure while checking roughness from the waveform!

Printing completes in just a few seconds! (**SJ-310**)



### With the **SJ-210/310 Series...**

No need to haul large, heavy workpieces because you can measure on-site!

Lightweight and compact, you can measure any side without trouble!



### With the **SJ-210/310 Series...**

Anyone can measure easily with skidded measurement\*!

\* A measurement method where leveling of the measurement surface is simplified since displacement is measured relative to the "skid" that follows the workpiece surface.





## So easy that anyone can use it!

Reduces data input labor significantly:

Wireless measurement data communication system

### U-WAVE (optional)



Example of SJ-210 installation



Example of SJ-310 installation

“U-WAVE” is a system that allows measured parameter values to be imported to commonly used software (Excel, notepad, etc.) at the touch of a button. Being wireless, it does not affect the operability during measurement, and contributes to reducing data input labor and error, thereby improving work efficiency.



**U-WAVE-R**  
(Connects to the PC)  
**02AZD810D**



**U-WAVE-T\***  
(Connects to the SJ-210/310 Series)  
**02AZD880G**  
\* Requires separate connection cable.  
**02AZD790D**

Input at the touch of a button

### USB INPUT TOOL (optional)

An interface that transmits the calculation results of the SJ-210/310 Series via USB to spreadsheet software on a PC allows you to input calculation results (numerical values) at the touch of a button. Allows you to input the calculation results (numerical values) at the touch of a button.



USB Input Tool-Direct  
**USB-ITN-D**  
**06AFM380D**



USB keyboard signal conversion type\*  
**IT-016U**  
**264-016-10**  
\* Requires separate connection cable.  
1 m: **936937**  
2 m: **965014**

# Time-saving and user-friendly! Advanced free software!

Further improve convenience by linking with a PC

## USB Communication Tool for SURFTEST SJ

The program can not only start a measurement or change measurement conditions from a PC, but also create inspection record tables using Microsoft Excel macros. This allows you to operate SJ-210/310 Series more conveniently and significantly reduce the time needed for creating reports.

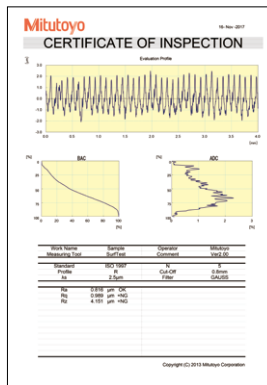
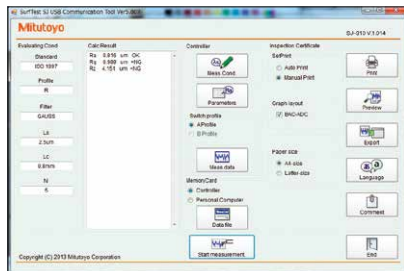

This program can be downloaded free of charge from the Mitutoyo website.  
[https://www.mitutoyo.eu/en\\_us/downloads/software-and-updates](https://www.mitutoyo.eu/en_us/downloads/software-and-updates)

### Required environment

- OS: Windows 7, Windows 8, Windows 10
- Spreadsheet software: Microsoft® Excel 2010, Microsoft® Excel 2013, Microsoft® Excel 2016, Microsoft® Excel 2019, Office365® ProPlus (Windows10 Pro)

Note: Windows OS, Microsoft® Excel, and Office365 ProPlus are products of Microsoft Corporation.

### A separate USB cable is also required.

- USB cable for SJ-210 Series (2 m) **12AAL068**  
 Note: Commercially available USB Mini Type B cable or equivalent
- USB cable for SJ-310 Series **12AAD510**  
 Note: Commercially available USB Type B cable or equivalent

### Optional combinations! Improve work efficiency by utilizing diverse options

#### Contour/Roughness analysis software FORMTRACEPAK-AP

Data collected by the SJ-210/310 Series can be loaded to FORMTRACEPAK-AP, a form assessment/analysis software package, via a memory card (optional) for more advanced analysis.

#### Digimatic mini processor DP-1VA LOGGER

Simply connect this printer to the SurfTest SJ-210/310 Series' digimatic output and print\* calculation results, perform a variety of statistical analyses, draw a histogram or D chart, and also perform complicated operations for X-R control charts.

\* The symbol 'µm' is not printable, but measurement results can still be printed out without setting the measurement unit.



264-505

- SJ-210/310 Series → DP-1VA LOGGER Connecting cable
  - 1 m: 936937
  - 2 m: 965014

#### Foot switch

Start and stop measurements just by tapping! Allows you to significantly increase efficiency in measurements where large numbers of the same workpiece are fixed and measured in one go.



12AAJ088

#### Memory card (2 GB)



- 12AAW452
  - Note 1: micro SD card (with a conversion adapter to SD card)
  - Note 2: Not all memory cards can be recognized. Please use the optional SD memory card.

# The Convenient Functions of the SJ-210/310 Series 6

## Enhance versatility by linking tester capabilities!

### - SJ-210/310 Linkage -

"Measuring with the compact and easy-to-carry SJ-210, while analyzing and printing with highly functional SJ-310" is a useful feature.

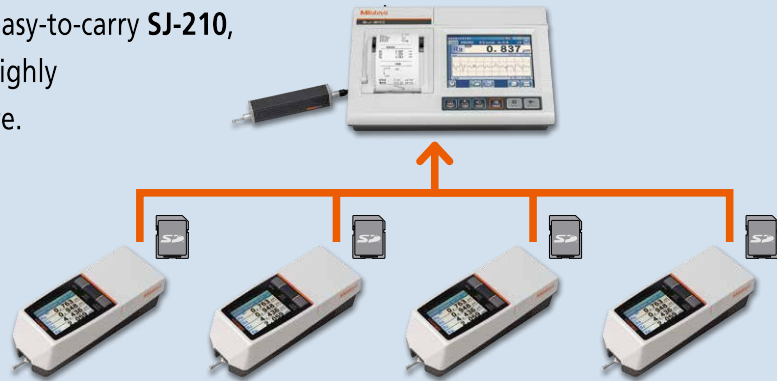

## Avoid annoying mishaps, such as forgetting to save or erroneously deleting data. - Trace 10 -

Enables displaying of the past 10 automatically saved calculation results. Allows for immediately checking of "recent numerical values" that you just cannot recall.



Note: Requires a memory card (optional).

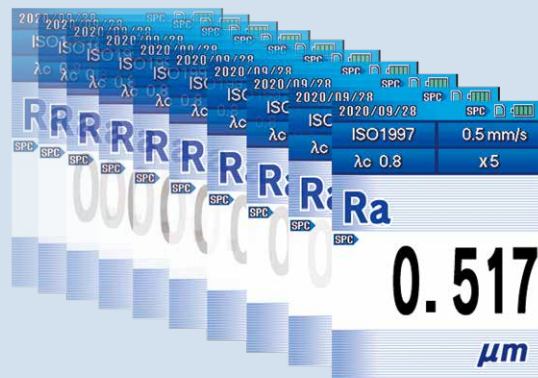

## Just choose the assessment conditions from the list.

### - Single-Screen Parameter List -

Use the colorful graphic LCD to specify your settings with ease.

Chosen parameters are easily identifiable by their different background and letter color.

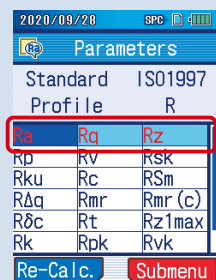

Parameter setting on SJ-210



Parameter setting on SJ-310



## Don't stress about hard-to-see points with reliable contact detection!

### - Contact Status Screen Display -

The detector contact status can be reliably judged by the red or blue colors on the display.



Display of SJ-210

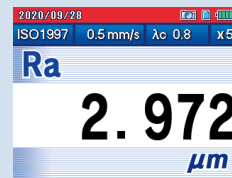

No Contact Detected



Contact Detected

Display of SJ-310

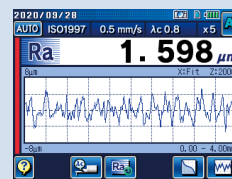

No Contact Detected

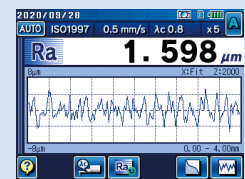

Contact Detected

## No more erroneous measurements from vibrations!

### - Self-Timer -

No need to worry about erroneous measurements due to vibration since measurement can be started after the vibration subsides.

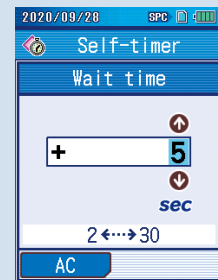
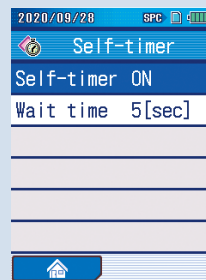

## Using passwords means less worries for administrators!

### - Function Restriction -

Allows locking of optional items, such as measurement and calibration conditions. Prevents erroneous measurements due to a careless setting change or accidental operation.

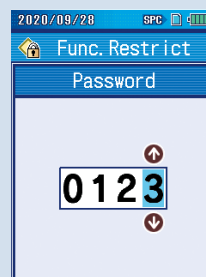

Password setting



## SJ-210 Series - Further Sophisticated Functions

### Outstanding visibility! 2.4-inch color graphic LCD

A clear and easy to read large screen with backlight.

### Clearly arranged GO/NG judgment screen

Clearly determine results at a glance -  
pass and fail are indicated in different colors.

2020/09/28		SPC	[Battery]	
ISO1997	0.5 mm/s	$\lambda_c$ 0.8	x5	
Ra	<b>0.664</b>	$\mu\text{m}$	OK	
Rq	<b>0.808</b>	$\mu\text{m}$	NG	
Rz	<b>3.767</b>	$\mu\text{m}$	NG	
Rp	<b>1.866</b>	$\mu\text{m}$	NG	

### User-friendly operation keys: No more accidental operation!

Frequently used keys are arranged on the top surface of the main unit.

Rarely used keys are located under the cover to prevent accidental operation.



### Shortcuts for intuitive operation

Display settings can be easily changed by operating the [←] and [→] keys inside the cover. For example, cutoff value ( $\lambda_c$ ), and number of segments (N) can be easily switched on the measurement screen.



### Perfectly mobile: Easy to carry

Convenient, dedicated case for comfortable carrying (Standard accessory)



### High-speed measurement data transmission

Equipped with several I/O ports, including a high-speed USB interface, as standard.



### Printer for SJ-210 (optional)

Assessed profiles, calculation results, and curves can be printed out by connecting the SJ-210-dedicated printer. Palm-sized (WxDxH: 93x125x70 mm)

- Printable values: Measurement conditions, calculation results, assessed profile, bearing area curve (BAC), amplitude distribution curve (ADC), and environment settings.



178-423D

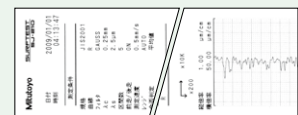

Example of a printout

#### Printer supplies:

- Printing paper standard type (5 rolls) 270732
- Durable printer paper (5 rolls) 12AAA876

# Surftest SJ-210 Series



# SJ-310 Series - Further Sophisticated Functions



**Supports measurement with outstanding visibility on the large 5.7-inch color LCD**

The large touch-panel LCD provides optimum operability for smooth measurements.

**The built-in high-speed printer, allows for printing measurement results anytime and anywhere**

All processes from measuring to printing the measurement results can be completed just by pressing a single button. Printing takes just a few seconds!

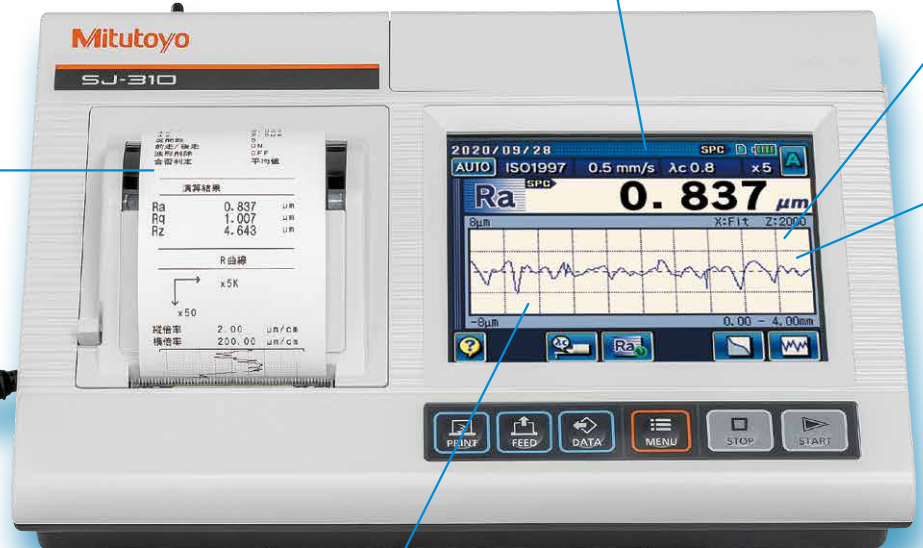

**The simultaneous two-curve assessment function enables advanced utilization of measurement data**

Allows acquisition of calculation and analysis results according to two different assessment conditions from one measurement.

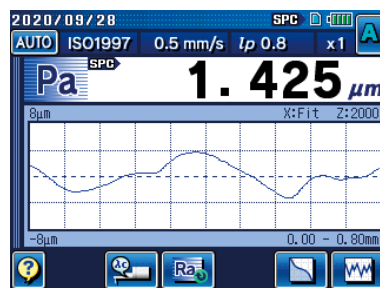
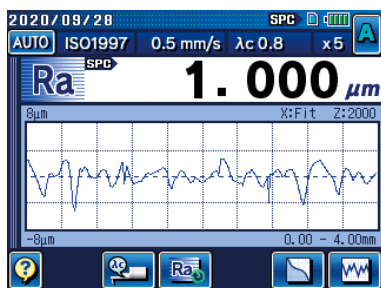

**The delete function widens the utilization range of the data**

Allows calculation by partially deleting abnormal results, such as cracks.

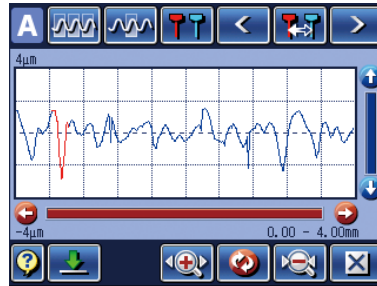

**Coordinate difference analysis promptly picks up the workpiece status**

Allows calculation of the coordinate difference between two waveform points. This lets you check workpiece unevenness on the screen, without printing.

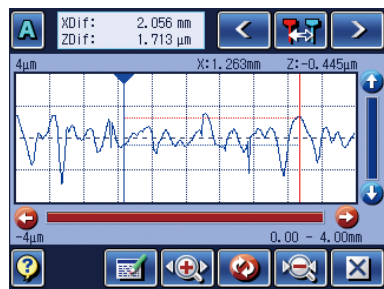

**Statistical processing for perfect data management**

Capable of up to 300 statistical measurements for a maximum of three parameters, enabling routine data to be appropriately managed.

Stat. Result	
<b>Ra</b>	SampleSize 5
Mean [X̄]	1.108 μm
Std. Dev. [σ]	0.056 μm
Max.	1.181 μm
Min.	1.029 μm
Pass Rate	0.0 %

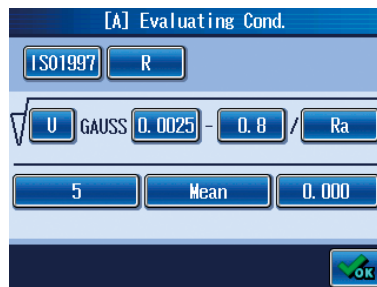
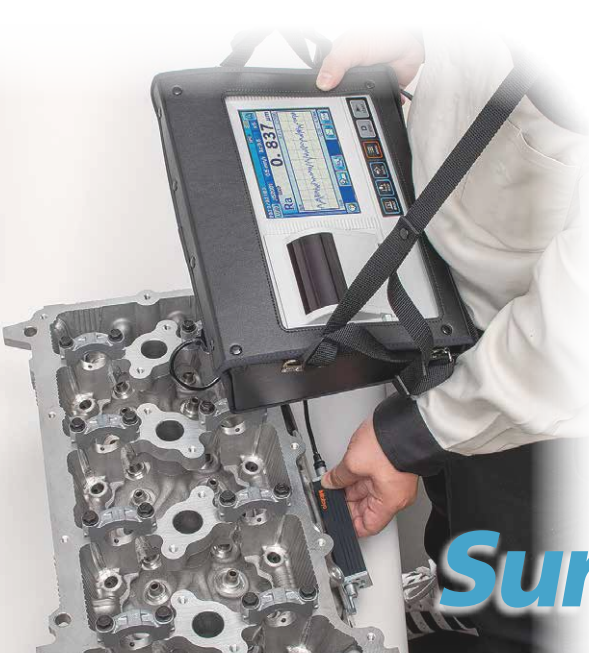
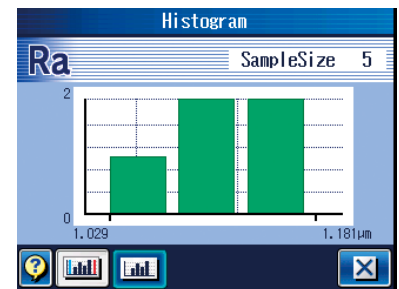

**Condition inputting possible in drawing instruction format**

Also allows for assessment condition inputting using drawing instruction symbols compliant with ISO/JIS roughness standards.

**Surftest SJ-310 Series**

# SJ-210 Series Specifications

Type of detector		Standard drive unit type		Retractable drive unit type		Transverse tracing drive unit type	
Model No.		SJ-210 (0.75 mN type)	SJ-210 (4 mN type)	SJ-210R (0.75 mN type)	SJ-210R (4 mN type)	SJ-210S (0.75 mN type)	SJ-210S (4 mN type)
Order No.	mm	178-560-11 178-560-13	178-560-12	178-562-11	178-562-12	178-564-11	178-564-12
	inch/mm	178-561-11	178-561-12	178-563-11	178-563-12	178-565-11	178-565-12
X-axis		16,0 mm				5,6 mm	
Measuring range	X-axis	360 µm (-200 µm to +160 µm)					
	Z-axis (Detector)	360 µm/0,02 µm 100 µm/0,006 µm 25 µm/0,002 µm					
Measuring speed		When measuring: 0,25 mm/s, 0,5 mm/s, 0,75 mm/s When returning: 1 mm/s					
Measuring force/Stylus tip		0,75 mN type: 0,75 mN/2 µmR 60°, 4 mN type: 4 mN/5 µmR 90°					
Skid force		400 mN or less					
Applicable standards		JIS '82/JIS '94/JIS '01/ISO '97/ANSI/VDA					
Assessed profiles		Primary profile, Roughness profile, DF profile, Roughness profile-Motif					
Parameters		Ra, Rc, Ry, Rz, Rq, Rt, Rmax <sup>*1</sup> , Rp, Rv, R3z, Rsk, Rku, Rc, Rpc, Rsm, Rz1max <sup>*2</sup> , S, HSC, RzJIS <sup>*3</sup> , Rppi, R Δ a, R Δ q, Rlr, Rmr, Rmr(c), R δ c, Rk, Rpk, Rvk, Mr1, Mr2, A1, A2, Vo, Rpm, tp <sup>*4</sup> , Htp <sup>*4</sup> , R, Rx, AR, Possible Customize					
Graph analysis		Bearing area curve, Amplitude distribution curve					
Filters		Gaussian, 2CR75, PC75					
Cut off length	λc	0,08, 0,25, 0,8, 2,5 mm					
	λs <sup>*5</sup>	2,5, 8 µm					
Sampling length		0,08, 0,25, 0,8, 2,5 mm					
Number of sampling lengths		×1, ×2, ×3, ×4, ×5, ×6, ×7, ×8, ×9, ×10, arbitrary length (0,3 to 16,0 mm: 0,01 mm interval)				×1, ×2, ×3, ×4, ×5, ×6, ×7, ×8, ×9, ×10, arbitrary length (0,3 to 5,6 mm: 0,01 mm interval)	
LCD dimensions		36,7×48,9 mm					
Display languages		All models except 178-560-13D: Japanese, English, German, French, Italian, Spanish, Portuguese, Korean, Traditional Chinese, Simplified Chinese, Czech, Polish, Hungarian, Turkish, Swedish, Dutch 178-560-13D: Japanese, English, Russian, Slovenian, Rumanian, Bulgarian, Finnish, German, French, Italian, Spanish, Czech, Polish, Hungarian, Turkish, Swedish					
Measurement result display		Vertical display: 1-parameter display/3-parameter display/Trace display Horizontal display: 1-parameter display/4-parameter display/Trace display (Horizontal display is invertible)					
Printing function <sup>*6</sup> (Dedicated printer is required separately)		Measurement conditions/Calculation results/GO/NG judgement result/Calculation results for each sampling length/ Assessed profile/Bearing area curve/Amplitude distribution curve/Environment setting information					
External I/O		USB I/F, Digimatic Output, Printer Output, RS-232C I/F, Foot SW I/F					
Customization		Desired parameters can be selected for calculation and display					
GO/NG judgment <sup>*7</sup>		By max value/16 %/Standard deviation					
Storage of measurement condition		Save the conditions at power OFF					
Functions	Storage	Internal memory: Measurement condition (10 sets) Memory card (optional): 500 measurement conditions, 10000 measured profiles, 500 display images Text file (Measurement conditions/Measured profile/Assessed profile/ Bearing area curve/Amplitude distribution curve)					
	Calibration	Auto-calibration with the entry of numerical value/ Average calibration with multiple measurements (Max. 5 times) is available					
Power-saving function		Auto-sleep function (10-600 sec) <sup>*8</sup>					
Power supply		Two-way power supply: battery (rechargeable NiMH battery) and AC adaptor Note 1: Charging time: about 4 hours (may vary due to ambient temperature) Note 2: Endurance: about 1000 measurements (differs slightly due to use conditions/environment)					
Size (WxDxH)	Display unit	52,1×65,8×160 mm (sliding cover closed, detector not mounted)					
	Drive unit	115×23×26 mm (detector not mounted)					
Mass		About 500 g (Display unit + Drive unit + Standard detector)					
Standard accessories		<b>12BAA303</b> Connecting cable <sup>*9</sup> <b>178-601</b> Roughness specimen (Ra 3 µm) <b>12BAR344</b> Carrying case <b>12BAK700</b> Calibration stage Protective sheets for display, AC Adapter, Operation manual, Quick reference manual, Warranty				<b>12BAA303</b> Connecting cable <sup>*9</sup> <b>178-605</b> Roughness specimen (Ra 1 µm) <b>12AAE643</b> Point-contact adapter <b>12AAE644</b> V-type adapter <b>12BAR344</b> Carrying case <b>12BAK700</b> Calibration stage Protective sheets for display AC Adapter, Operation manual Quick reference manual, Warranty	

\*1 Calculation is available only when selecting the VDA, ANSI, or JIS '82 standard.

\*2 Calculation is available only when selecting the ISO '97 standard.

\*3 Calculation is available only when selecting the JIS '01 standard.

\*4 Calculation is available only when selecting the ANSI standard.

\*5 Not available when selecting the JIS '82 standard.

\*6 Order the **SJ-210** printer (**178-421D**, optional accessory) separately.

\*7 Standard deviation can only be selected in ANSI. 16 % rule cannot be selected in VDA.

\*8 Auto-sleep function is invalid when AC adaptor is used.

\*9 For connecting the calculation display unit and drive unit.

Note 1: Refer to pages 18 to 19 for details about consumables and options.

Note 2: To denote your AC line voltage add the following suffixes (e.g. **178-560-11A**).

A for 120 V, C for 100 V, D for 230 V, E for 230 V (for UK), DC for 220 V (for China), K for 220 V (for Korea)



# SJ-210 Series Dimensions

- Drive unit stored inside display unit (Standard detector installed in drive unit)

Unit: mm

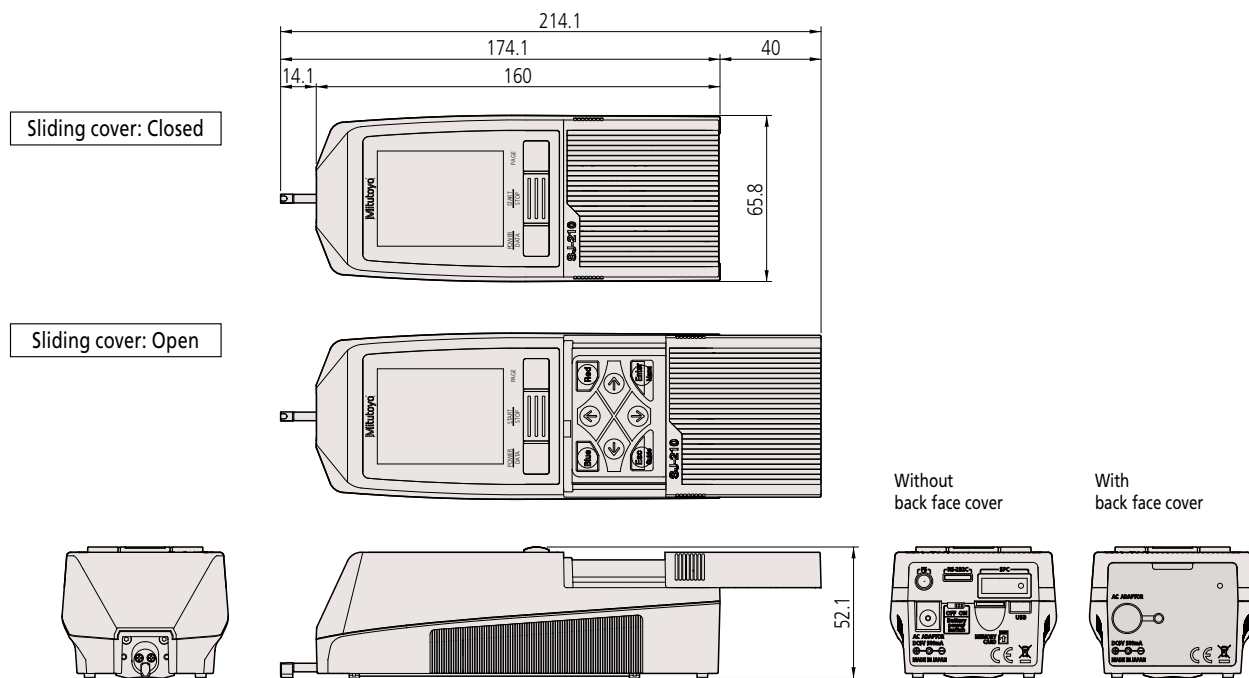

- Drive unit not stored inside display unit (Standard detector installed in drive unit)

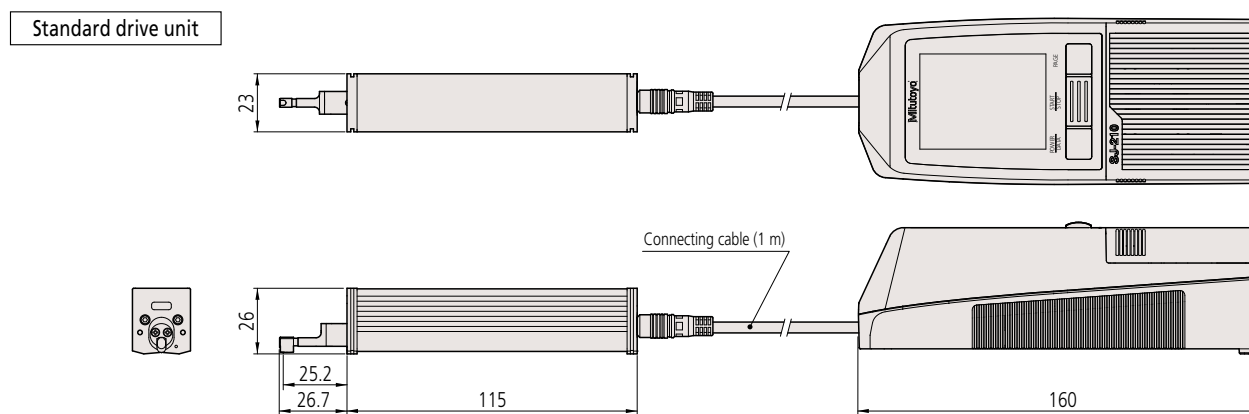

# SJ-310 Series Specifications

Type of detector	Standard drive unit type		Retractable drive unit type		Transverse tracing drive unit type		
Model No.	SJ-310 (0.75 mN type)	SJ-310 (4 mN type)	SJ-310R (0.75 mN type)	SJ-310R (4 mN type)	SJ-310S (0.75 mN type)	SJ-310S (4 mN type)	
Order No.	mm	178-570-11	178-570-12	178-572-11	178-572-12	178-574-11	178-574-12
	inch/mm	178-571-11	178-571-12	178-573-11	178-573-12	178-575-11	178-575-12
X-axis	16.0 mm				5.6 mm		
Measuring range	Range	360 μm (-200 μm to +160 μm) [14400 μinch (-7900 μinch to +6300 μinch)]					
	Detector Range/resolution	360 μm/0,02 μm 100 μm/0,006 μm 25 μm/0,002 μm					
Measuring speed	When measuring: 0,25 mm/s, 0,5 mm/s, 0,75 mm/s, When returning: 1 mm/s						
Measuring force/Stylus tip	0,75 mN type: 0,75 mN/2 μmR 60°, 4 mN type: 4 mN/5 μmR 90°						
Skid force	400 mN or less						
Applicable standards	JIS '82/JIS '94/JIS '01/ISO '97/ANSI/VDA						
Assessed profiles	Primary profile, Roughness profile, DF profile, Roughness profile-Motif, W-Motif						
Parameters	Ra, Rc, Ry, Rz, Rq, Rt, Rmax <sup>1</sup> , Rp, Rv, R3z, Rsk, Rku, Rc, Rpc, Rsm, Rz1max <sup>2</sup> , S, HSC, RzJIS <sup>3</sup> , Rppi, RΔa, RΔq, Rlr, Rmr, Rmr(c), Rδc, Rk, Rpk, Rvk, Mr1, Mr2, A1, A2, Vo, λa, λq, LO, Rpm, tp <sup>4</sup> , Htp <sup>4</sup> , R, Rx, AR, W, AW, Wx, Wte, Possible Customize						
Graph analysis	Bearing area curve, Amplitude distribution curve						
Filters	Gaussian, 2CR75, PC75						
Cut-off length	λc	0,08, 0,25, 0,8, 2,5, 8 mm					
	λs <sup>5</sup>	2,5, 8 μm					
Sampling length	0,08, 0,25, 0,8, 2,5, 8 mm						
Number of sampling lengths	x1, x2, x3, x4, x5, x6, x7, x8, x9, x10, Arbitrary (0.3 to 16.0 mm: 0.01 mm Interval)				x1, x2, x3, x4, x5, x6, x7, x8, x9, x10, Arbitrary (0.3 to 5.6 mm: 0.01 mm Interval)		
LCD dimensions	117.8x88.2 mm						
Display languages	Japanese, English, German, French, Italian, Spanish, Portuguese, Korean, Traditional Chinese, Simplified Chinese, Czech, Polish, Hungarian, Turkish, Swedish, Dutch						
Measurement result display	1-parameter display: one parameter measurement result 4-parameter display: four parameter measurement results Profile display: one parameter measurement result and the measured profile Trace display: The ten latest measurement results using the same parameter						
Printing function	Measurement conditions/Calculation results/GO/NG judgement result/Calculation results for each sampling length/Tolerance value/Assessed profile/Graphic curve/Bearing area curve/Amplitude distribution curve/Environmental setting information						
External I/O	USB I/F, Digimatic output, RS-232C I/F, External SW I/F						
Functions	Customization	Desired parameters can be selected for calculation and display					
	GO/NG judgement <sup>6</sup>	Max rule/16 % rule/Average rule/Standard deviation (1σ, 2σ, 3σ)					
	Storage of measurement condition	Save the condition at power OFF					
	Storage	Internal memory: Measurement condition (10 sets) Memory card (optional): 500 measurement conditions, 10000 measuring data, 500 statistic data, 10000 text data, 1 backup of machine setting, the last ten traces (Trace 10)					
Calibration	Auto-calibration with the entry of numerical value/Average calibration with multiple measurements (Max. 12 times) is available						
Power-saving function	Auto-sleep function (30-600 sec) <sup>7</sup>						
Power supply	Two-way power supply: battery (rechargeable Ni-MH battery) and AC adapter Note 1: Charging time: about 4 hours (may vary due to ambient temperature) Note 2: Endurance: about 1500 measurements (differs slightly due to use conditions/environment)						
Size (WxDxH)	Display unit	275x109x198 mm					
	Drive unit	115x23x26 mm (detector not mounted)					
Mass	About 1.8 kg (Display unit + Drive unit + Standard detector)						
Standard accessories	<b>12AAW066</b> Connecting cable <sup>8</sup> <b>178-601</b> Roughness specimen (Ra 3 μm) <b>357651</b> AC adapter <b>12AAA217</b> Nosepiece for plane surface <b>12AAA218</b> Nosepiece for cylinder <b>12AAA216</b> Supporting leg <b>12BAK700</b> Calibration stage <b>12BAR507</b> Stylus pen <b>12BAL402</b> Protection sheet <b>270732</b> Printer paper (5 rolls) <b>12BAL400</b> Carrying case Philips screwdriver, Strap for stylus pen, Operation manual, Quick reference manual, Warranty				<b>12AAW066</b> Connecting cable <sup>8</sup> <b>178-605</b> Roughness specimen (Ra 1 μm) <b>357651</b> AC adapter <b>12AAE643</b> Point-contact adapter <b>12AAE644</b> V-type adapter <b>12BAK700</b> Calibration stage <b>12BAR507</b> Stylus pen <b>12BAL402</b> Protection sheet <b>270732</b> Printer paper (5 rolls) <b>12BAL400</b> Carrying case Philips screwdriver, Strap for stylus pen, Operation manual, Quick reference manual, Warranty		

\*1 Only for VDA/ANSI/JIS '82 standards.

\*2 Only for ISO '97 standard.

\*3 Only for JIS '01 standard.

\*4 Only for ANSI standard.

\*5 Not available for JIS '82 standard.

\*6 Standard deviation can only be selected in ANSI. 16 % rule cannot be selected in VDA.

\*7 Auto-sleep function is invalid when AC adapter is used.

\*8 For connecting the calculation display unit and drive unit.

Note 1: Refer to pages 18 to 19 for details about consumables and options.

Note 2: To denote your AC line voltage add the following suffixes (e.g. **178-570-11A**). A for 120 V, C for 100 V, D for 230 V, E for 230 V (for UK), DC for 220 V (for China), K for 220 V (for Korea)

# SJ-310 Series Dimensions

• SJ-310 Series Display unit

Unit: mm

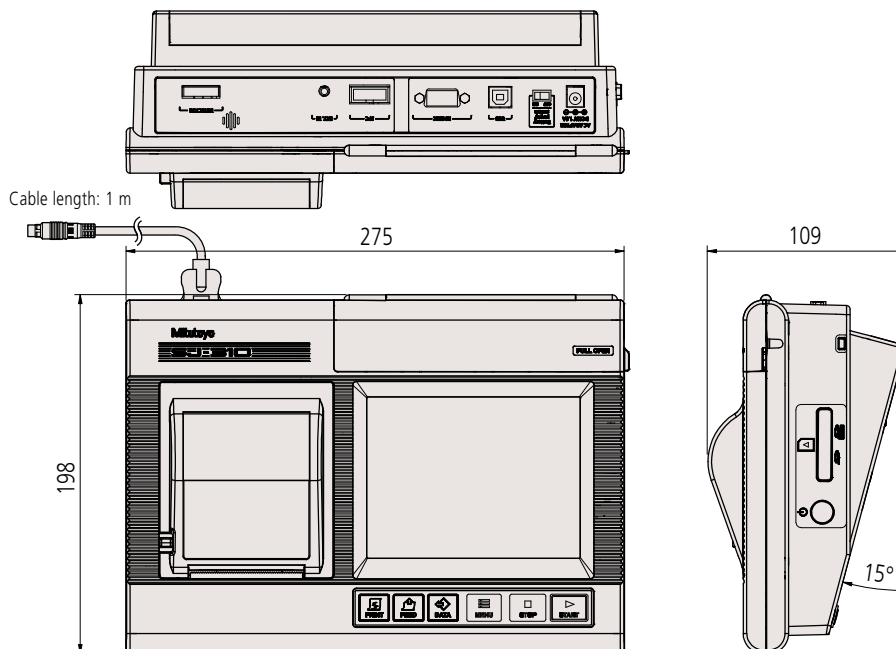

• Drive unit

Unit: mm

Drive unit type	Drive unit external view*
Standard drive unit	<p>23.0</p> <p>26.0</p> <p>25.2</p> <p>26.7</p> <p>115.0</p>
Retractable drive unit	<p>23.0</p> <p>26.0</p> <p>2.0</p> <p>23.2</p> <p>26.7</p> <p>115.0</p>
Transverse tracing drive unit	<p>23.0</p> <p>26.0</p> <p>3.0</p> <p>6.6</p> <p>45.5</p> <p>47</p> <p>115.0</p>

\* External dimension for the models with standard detector conforms to each drive unit.



# Detectors Dimensions

Unit: mm

## Standard detectors

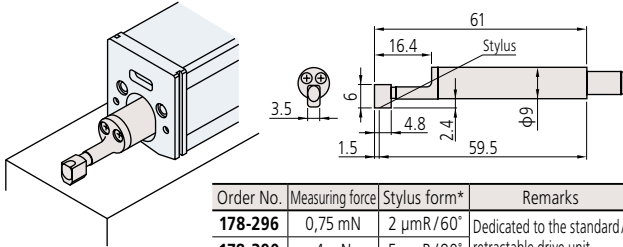

Order No.	Measuring force	Stylus form*	Remarks
<b>178-296</b>	0,75 mN	2 μmR / 60°	Dedicated to the standard/retractable drive unit
<b>178-390</b>	4 mN	5 μmR / 90°	
<b>178-387</b>	0,75 mN	2 μmR / 60°	Dedicated to the transverse tracing drive unit
<b>178-386</b>	4 mN	5 μmR / 90°	
<b>178-391</b>	4 mN	10 μmR / 90°	Dedicated to the standard/retractable drive unit

• Minimum measurable hole diameter  
 Hole depth=less than 12 mm: φ7 mm  
 Hole depth=12 - 22 mm: φ12 mm

\* Tip radius/Tip angle

## Gear-tooth surface detectors

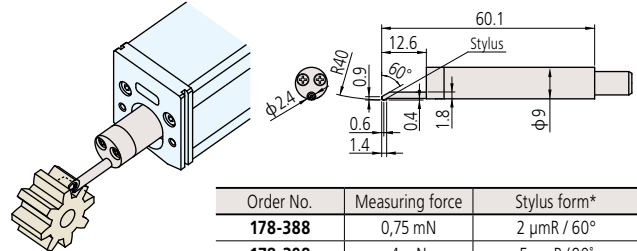

Order No.	Measuring force	Stylus form*
<b>178-388</b>	0,75 mN	2 μmR / 60°
<b>178-398</b>	4 mN	5 μmR / 90°

\* Tip radius/Tip angle

## Small hole detectors

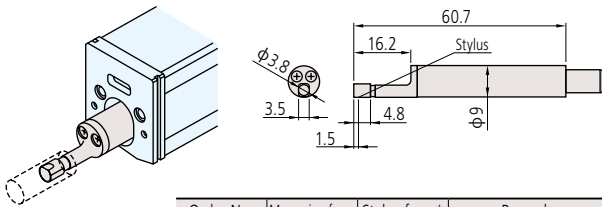

Order No.	Measuring force	Stylus form*	Remarks
<b>178-383</b>	0,75 mN	2 μmR / 60°	Minimum measurable hole diameter: φ4.5 mm
<b>178-392</b>	4 mN	5 μmR / 90°	

\* Tip radius/Tip angle

## Deep groove detectors

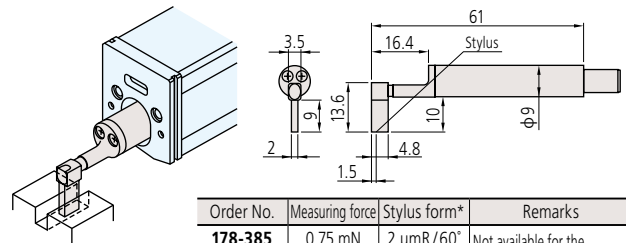

Order No.	Measuring force	Stylus form*	Remarks
<b>178-385</b>	0,75 mN	2 μmR / 60°	Not available for the transverse tracing drive unit
<b>178-394</b>	4 mN	5 μmR / 90°	

\* Tip radius/Tip angle

## Extra small hole detectors

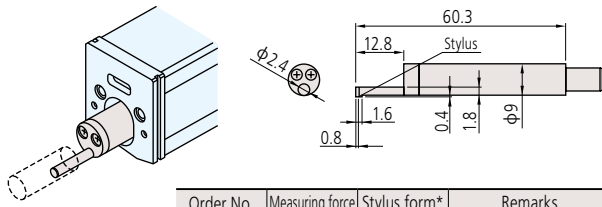

Order No.	Measuring force	Stylus form*	Remarks
<b>178-384</b>	0,75 mN	2 μmR / 60°	Minimum measurable hole diameter: φ2.8 mm
<b>178-393</b>	4 mN	5 μmR / 90°	

\* Tip radius/Tip angle

## How to identify the stylus tip radius

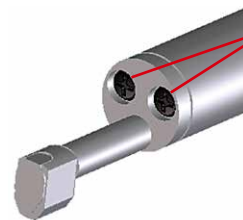

Nose mounting screw (2 pcs.)  
 Black: 2 μm  
 White: 5 μm  
 Yellow: 10 μm

## Custom-made for special order

Any specified detector other than the above listed can be custom-made for special order. Please consult your local Mitutoyo sales office.

## Optional Accessories for SJ-210 Series

- Optional accessories and consumables for **SJ-210**  
 Protective sheet for the color LCD (5-sheet set) **12AAL066**  
 Connecting cable (for SJ-210 Series) **12AAL067**

## Optional Accessories for SJ-310 Series

- Optional accessories and consumables for **SJ-310**  
 Printer paper standard type (5 rolls) **270732**  
 Durable printer paper (5 rolls) **12AAA876**  
 Touch-screen protector sheet (10 sheets) **12AAN040**  
 Connecting cable (for SJ-310 Series) **12AAA882D**



# Optional Accessories for SJ-210/310 Series

## • Drive unit accessories

### Nosepiece for flat surfaces



Note 1: Standard accessory for the standard/retractable drive unit of the **SJ-310** Series  
Note 2: Not available for the transverse tracing drive unit.

### Nosepiece for cylindrical surfaces



Note 1: Standard accessory for the standard/retractable drive unit of the **SJ-310** Series  
Note 2: Not available for the transverse tracing drive unit.

### Support feet set

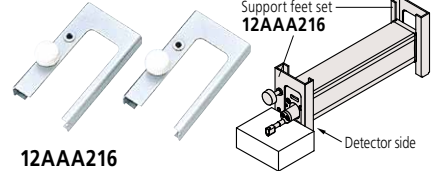

Note 1: Standard accessory for the standard/retractable drive unit of the **SJ-310** Series  
Note 2: Not attachable to the detector side of the transverse tracing drive unit.

### V-type adapter

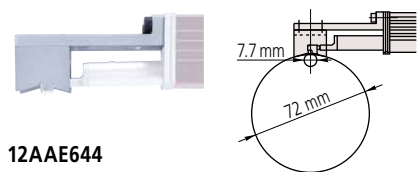

Note 1: Transverse tracing type standard accessory.  
Note 2: Dedicated to the transverse tracing drive unit.

### Point-contact adapter

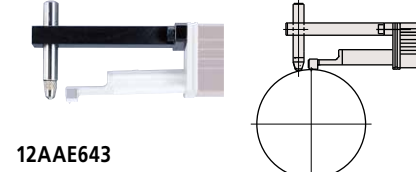

Note 1: Transverse tracing type standard accessory.  
Note 2: Dedicated to the transverse tracing drive unit.

### Extension rod (50 mm)

Note: Only one rod can be used.

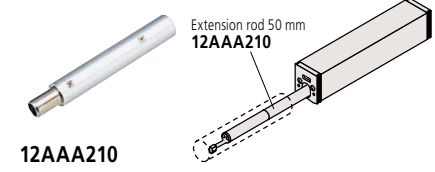

Note: Not available for the transverse tracing drive unit.

### Vertical positioning adapter

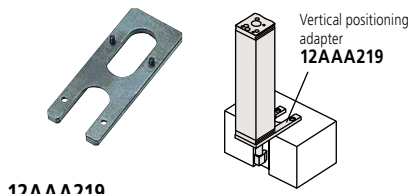

Note: Not available for the transverse tracing drive unit.

### Height gauge adapter

Note: Suitable for a height gauge holder designed for 9x9 mm section scribers.

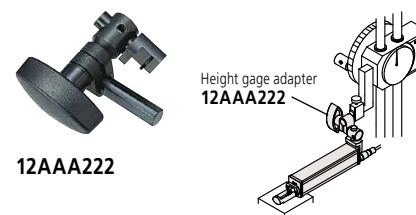

**12AAA222**

### Magnetic stand adapter

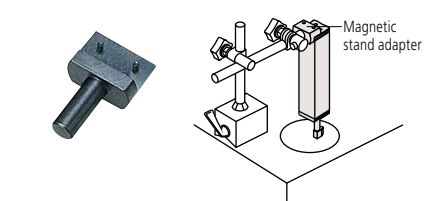

**12AAA221**  
(Mounting spigot diameter is 8 mm)

### Roughness specimen Ra 0,4 / Ra 3 µm [mm]

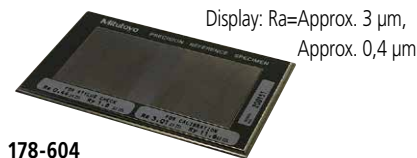

Note: Ra=Approx. 0.4 µm can only be used for stylus tip checking.

### Extension cable (1 m)

Note: Only one rod can be used.

**12BAA303**  
Note: For connecting calculation display unit and drive unit.

### Magnetic stand adapter

**12AAA220**  
(Mounting spigot diameter is 9.5 mm)

### Granit stand

**178-029**  
Note: 12AAA221 needed



## • Setting attachments

Note: Not available for the transverse tracing drive unit

Enhances measurement efficiency by facilitating the measurement setup of multiple workpieces of the same type or the hard-to-access sections of a workpiece.

### Setting attachment: V type for measuring in the cylinder axis direction

The V-width is adjustable to the cylinder diameter facilitating axial measurement of a wide range of cylinder diameters.

- Adjustable range:  
ø5 - ø150 mm

**178-033**

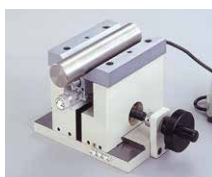

### Setting attachment: Slider type

This attachment is ideal for measuring a flat area of a workpiece that has an indentation or step that makes it difficult to attach the drive unit.

**178-034**



### Setting attachment: Inside diameter type

Greatly facilitates measurement of internal wall surfaces of, for example, a cylinder block.

- Applicable diameter:  
ø75 - ø95 mm
- Accessible depth:  
30 - 135 mm

**178-035**



• Custom-made upon special order Any specified attachment other than the above listed can be custom-made for special order. Please consult your local Mitutoyo sales office.  
Example: measurements for crankshaft, cylinder-block bores

Coordinate Measuring Machines



Vision Measuring Systems

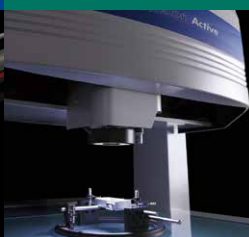

Form Measurement



Optical Measuring

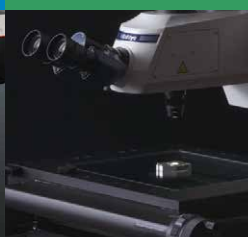

Sensor Systems

Test Equipment  
and Seismometers

Digital Scale and DRO Systems

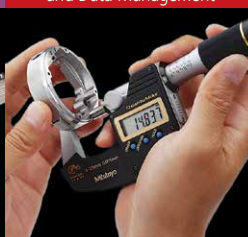
Small Tool Instruments  
and Data Management

Mitutoyo supports you from start to finish.

Mitutoyo is not only a manufacturer of top-quality measuring products but one that also offers qualified support for the lifetime of the equipment backed up by comprehensive services, ensuring your staff can make the very best use of the investment.

Apart from the basics of calibration and repair, Mitutoyo offers product and metrology training, as well as IT support for the sophisticated software used in modern measuring technology. We can also design, build, test, and deliver bespoke measuring solutions and even, if deemed cost-effective, take your critical measurement challenges in-house on a sub-contract basis.

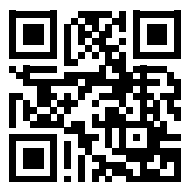

Find additional product literature and our complete catalog here.

[www.mitutoyo.se](http://www.mitutoyo.se)

**Note:** Product illustrations are without obligation. Product descriptions, in particular all technical specifications, are only binding when explicitly agreed upon. MITUTOYO and MICAT are either registered trademarks or trademarks of Mitutoyo Corp. in Japan and/or other countries/regions. Other product, company, and brand names mentioned herein are for identification purposes only and may be the trademarks of their respective holders.

# Mitutoyo

Mitutoyo Scandinavia AB

Släntvägen 6

SE-194 27 Upplands Väsby

Tel. +46 (0) 8 594 109 50

[kontakt@mitutoyo.se](mailto:kontakt@mitutoyo.se)

[www.mitutoyo.se](http://www.mitutoyo.se)